

KUSINA®

www.kusina.com.tr



INDEX/İÇİNDEKİLER

1 - Cooking Series/Piřirici Serisi

Silver	05
Series 600	15
Series 700	41
Series 700S	99
Series 900	123

2 - Classic Cooking Series/Klasik Piřirici Serisi

Stock Pot Stoves - Yer Ocakları	173
---------------------------------------	-----

3 - Other Cooking/Diđer Piřirici

Salamanders - Salamender	181
Stone Oven - Tař Fırın	181

4 - Charcoal Grill/Kömür Izgara

Charcoal Grill - Kömürlü Izgara	185
---------------------------------------	-----

5 - Banquet Trolleys/Banquet Arabaları

Banquet Trolleys - Banquet Arabaları	193
Hot Banquet Trolleys - Sıcak Banquet Arabaları	195

6 - Food Servery Counters/Yemek Servis Hatları

Nova Series - Nova Serisi	200
Classic Series - Klasik Serisi	217
Drop-In Display - Dropin Vitrinler	237

7 - Trolleys/Arabalar

Trolleys - Arabalar	249
Shelving Systems - Raf Sistemleri	260
Hoods - Davlumbazlar	262

KUSINA®

COOKING SERIES - PİŞİRİCİ SERİSİ

Silver Series • Silver Seri



Silver Series • Silver Seri



GENERAL FEATURES

- Kusina silver line is designed for fast-foods, small restaurants and hotels and small scaled catering units up to 100 meals per day
- The silver line composed of compact equipment, with quality and performance that meet the needs of professional chefs.
- Silver line is consisting of electrical powered equipments coming with modular system, sizes are smaller compared to 600 serie .
- This a complete basic cooking system with various powers and ideal for small rooms, ensures safety and energy savings at low cost.

GENEL ÖZELLİKLER

- Kusina silver serisi günde 100 yemek servisini aşamayan küçük restoranlar, oteller ve yemek üreticileri için tasarlanmıştır.
- Profesyonel şeflerin beklentilerini karşılayacak kriterlerin tümüne sahip elektrikli ürünlerdir.
- 600 serisine kıyasla silver serisi daha küçüktür.
- Küçük mutfaklar için, farklı güçte seçenek sunabilen düşük maliyetli , enerji tasarruflu , güvenli bir seridir.

GENERAL FEATURES

- Stainless steel body
- Easy to clean and hygienic
- Ergonomic design
- Adjustable legs
- Durable

GENEL ÖZELLİKLER

- Paslanmaz çelik gövde
- Kolay temizlenebilir ve hijyenik
- Ergonomik tasarım
- Ayarlanabilir ayaklar
- Uzun ömürlü

S6K100E ⚡

Dim(mm)LxDxH - Ebat (mm):	300x600x300
Plates - Isıtıcı Pleyt	: 1,5 kW x 2
Power - Güç	: 3 kW
Gross Weight - Ağırlık	: 14,5 kg
Gross Volume - Hacim	: 0,13 m ³
Electrical Inlet - Elektrik Girişi	: 230 V 1 NPE
Price - Fiyat	: 348 €



S6K200E ⚡

Dim(mm)LxDxH - Ebat (mm):	600x600x300
Plates - Isıtıcı Pleyt	: 1,5 kW x 4
Power - Güç	: 6 kW
Gross Weight - Ağırlık	: 28 kg
Gross Volume - Hacim	: 0,28 m ³
Electrical Inlet - Elektrik Girişi	: 400 V 3 NPE
Price - Fiyat	: 535 €



PRODUCT SPECIFICATIONS

- 2 or 4 Ø 150 mm cooking plates
- Fast heating and high efficiency
- The power of each cooking plates 1500 w.
- Stage adjustable heat control

ÜRÜN DETAYLARI

- 2'li ve 4'lü Ø 150 mm pişirme pleyti
- Hızlı ısınma ve yüksek verim
- Pleyt güçleri her biri 1500 w.
- Kademeli sıcaklık kontrolü

GENERAL FEATURES

- Stainless steel body
- Quick easy cleaning
- Ergonomic design
- Adjustable legs
- Durable
- Adjustable temperature control
- Safety thermostat

GENEL ÖZELLİKLER

- Paslanmaz çelik gövde
- Kolay temizlenebilir hijyenik
- Ergonomik tasarım
- Ayarlanabilir ayaklar
- Uzun ömürlü
- Ayarlanabilir ısı derecesi
- Emniyet termostatu

S6F100E-6 ⚡

Dim(mm)LxDxH - Ebat (mm):	300x600x300
Power - Güç	: 6 kW
Gross Weight - Ağırlık	: 17,5 kg
Gross Volume - Hacim	: 0,13 m ³
Electrical Inlet - Elektrik Girişi	: 400 V 3N PE
Basket Size - Sepet Ölçüsü	: 195x245x130
Capacity - Kapasite	: 10 lt
Price - Fiyat	: 644 €



S6F200E-12 ⚡

Dim(mm)LxDxH - Ebat (mm):	600x600x300
Power - Güç	: 12 kW
Gross Weight - Ağırlık	: 31,5 kg
Gross Volume - Hacim	: 0,28 m ³
Electrical Inlet - Elektrik Girişi	: 400 V 3N PE
Basket Size - Sepet Ölçüsü	: 195x245x130 (2 Pcs)
Capacity - Kapasite	: 2x10 lt
Price - Fiyat	: 1.018 €



PRODUCT SPECIFICATIONS

- Single or double tanks options
- Thermostat controlled heating
- Stainless steel baskets
- Operation and heating temperature control lights
- Operating temperature range (0-180 °C)
- Security switches are easily accessible

ÜRÜN DETAYLARI

- Tekli veya çift havuzlu versiyonları
- Termostatik sıcaklık kontrolü
- Paslanmaz sepetler
- Çalıştırma ve sıcaklık sinyal lambaları
- Çalışma ısı aralığı (0-180 °C)
- Kolay ulaşılabilir emniyet svitçeri

GENERAL FEATURES

- Stainless steel body
- Quick easy cleaning
- Ergonomic design
- Adjustable legs
- Durable
- Homogenous cooking surface

GENEL ÖZELLİKLER

- Paslanmaz çelik gövde
- Kolay temizlenebilir hijyenik
- Ergonomik tasarım
- Ayarlanabilir ayaklar
- Uzun ömürlü
- Homojen pişirme yüzeyi

S6I100E ⚡

Dim(mm)LxDxH - Ebat (mm):	300x600x300
Power - Güç	: 2 kW
Gross Weight - Ağırlık	: 28 kg
Gross Volume - Hacim	: 0,15 m ³
Smooth - Düz	: 1/1
Electrical Inlet - Elektrik Girişi	: 230 V 1N PE
Price - Fiyat	: 542 €



S6I110E ⚡

Dim(mm)LxDxH - Ebat (mm):	300x600x300
Power - Güç	: 2 kW
Gross Weight - Ağırlık	: 31 kg
Gross Volume - Hacim	: 0,15 m ³
Ribbed - Oluklu	: 1/1
Electrical Inlet - Elektrik Girişi	: 230 V 1N PE
Price - Fiyat	: 617 €



PRODUCT SPECIFICATIONS

- Top plates are available in smooth, ribbed or in combination.
- ST 52 Grade Steel Griddle or Chromium coated plates 15 mm thick.
- 3 mm thickness splash guard
- Sloped cooking surface for easy maintenance with liquid drain
- Homogenous cooking surface
- Machined grooved plates
- Thermostatic temperature control
- Round corners to eas proper cleaning
- Large sized draining drawer
- Operating temperature range (50-320 ° C)

ÜRÜN DETAYLARI

- Pişirme yüzeyinin düz, oluklu veya oluklu + düz versiyonları
- 15 mm kalınlığında st 52 çelik veya sert krom kaplı çelik platina ızgaralar
- Pişirme yüzeyinin çevresi 3mm kalınlığında paslanmaz çelik
- Kolay ve rahat temizlik için hafif eğimli pişirme yüzeyi, sıvı boşaltma delikli
- Homojen pişirme yüzeyi
- Özel işlenmiş oluklar
- Termostatik sıcaklık kontrolü
- Yuvarlanmış köşeler ile kolay temizlenebilirlik
- Büyük kapasiteli yağ çekmecesini
- Çalışma ısı aralığı (50-320 ° C)

S6I150E ⚡

Dim(mm)LxDxH - Ebat (mm): 450x600x300
 Power - Güç : 3 kW
 Gross Weight - Ağırlık : 37,5 kg
 Gross Volume - Hacim : 0,16 m³
 Smooth - Düz : 1/1
 Electrical Inlet - Elektrik Girişi : 400 V 3N PE
 Price - Fiyat : 732 €

**S6I160E** ⚡

Dim(mm)LxDxH - Ebat (mm): 450x600x300
 Power - Güç : 3 kW
 Gross Weight - Ağırlık : 42,5 kg
 Gross Volume - Hacim : 0,16 m³
 Ribbed - Oluklu : 1/1
 Electrical Inlet - Elektrik Girişi : 400 V 3N PE
 Price - Fiyat : 750 €

**S6I200E** ⚡

Dim(mm)LxDxH - Ebat (mm): 600x600x300
 Power - Güç : 6 kW
 Gross Weight - Ağırlık : 49 kg
 Gross Volume - Hacim : 0,28 m³
 Smooth - Düz : 1/1
 Electrical Inlet - Elektrik Girişi : 400 V 3N PE
 Price - Fiyat : 786 €

**S6I210E** ⚡

Dim(mm)LxDxH - Ebat (mm): 600x600x300
 Power - Güç : 6 kW
 Gross Weight - Ağırlık : 54 kg
 Gross Volume - Hacim : 0,28 m³
 Ribbed - Oluklu : 1/1
 Electrical Inlet - Elektrik Girişi : 400 V 3N PE
 Price - Fiyat : 900 €



Pasta Cooker • Makarna Haşlama

Silver Series

GENERAL FEATURES

- Stainless steel body
- Quick easy cleaning
- Ergonomic design
- Adjustable legs
- Durable

S6M100E ⚡

Dim(mm)LxDxH - Ebat (mm):	300x600x300
Power - Güç	: 3 kW
Gross Weight - Ağırlık	: 18 kg
Gross Volume - Hacim	: 0,15 m ³
Electrical Inlet - Elektrik Girişi	: 400 V 3N PE
Basket Size - Sepet Ölçüsü	: 200x90x120 x 3 pcs
Capacity - Kapasite	: 10 lt
Price - Fiyat	: 593 €

PRODUCT SPECIFICATIONS

- Thermostat temperature control for safe operation
- On-off switch lights when reaching required temperature
- Operating temperature range (0-100 ° C)

Sauce Bain Marie • Sos Benmari

GENERAL FEATURES

- Stainless steel body
- Quick easy cleaning
- Ergonomic design
- Adjustable legs
- Durable
- GN containers are excluded, subject to separate order.

S6S100E ⚡

Dim(mm)LxDxH - Ebat (mm):	300x600x300
Power - Güç	: 1 kW
Gross Weight - Ağırlık	: 16 kg
Gross Volume - Hacim	: 0,15 m ³
Electrical Inlet - Elektrik Girişi	: 230 V 1N PE
Tank Capacity - Havuz Kapasitesi:	GN 1/4 x 3
Price - Fiyat	: 447 €

PRODUCT SPECIFICATIONS

- Drain valve with safety
- Operating temperature range (30-90 °C)

GENEL ÖZELLİKLER

- Paslanmaz çelik gövde
- Kolay temizlenebilir hijyenik
- Ergonomik tasarım
- Ayarlanabilir ayaklar
- Uzun ömürlü



ÜRÜN DETAYLARI

- Çalışma ve termostatlı sıcaklık kontrolü
- Sıcaklığa ulaştığında açma-kapama ışıkları
- Çalışma ısı aralığı (0-100 ° C)

GENEL ÖZELLİKLER

- Paslanmaz çelik gövde
- Kolay temizlenebilir hijyenik
- Ergonomik tasarım
- Ayarlanabilir ayaklar
- Uzun ömürlü
- Gn kaplar dahil değildir.



ÜRÜN DETAYLARI

- Emniyetli tahliye vanası
- Çalışma ısı aralığı (30-90 °C)

GENERAL FEATURES

- Stainless steel body
- Quick easy cleaning
- Ergonomic design
- Adjustable legs
- Durable

GENEL ÖZELLİKLER

- Paslanmaz çelik gövde
- Kolay temizlenebilir hijyenik
- Ergonomik tasarım
- Ayarlanabilir ayaklar
- Uzun ömürlü

S6D150E ⚡

Dim(mm)LxDxH - Ebat (mm): 450x600x300
Power - Güç : 1 kW
Gross Weight - Ağırlık : 17 kg
Gross Volume - Hacim : 0,16 m³
Electrical Inlet - Elektrik Girişi : 230 V 1N PE
Price - Fiyat : 340 €



Neutral Unit • Ara Tezgah

GENERAL FEATURES

- Stainless steel body
- Quick easy cleaning
- Ergonomic design
- Adjustable legs
- Durable

GENEL ÖZELLİKLER

- Paslanmaz çelik gövde
- Kolay temizlenebilir hijyenik
- Ergonomik tasarım
- Ayarlanabilir ayaklar
- Uzun ömürlü

S6T100N

Dim(mm)LxDxH - Ebat (mm): 300x600x300
Gross Weight - Ağırlık : 8,5 kg
Gross Volume - Hacim : 0,15 m³
Price - Fiyat : 167 €



S6T200N

Dim(mm)LxDxH - Ebat (mm): 600x600x300
Gross Weight - Ağırlık : 17 kg
Gross Volume - Hacim : 0,28 m³
Price - Fiyat : 191 €



GENERAL FEATURES

- Stainless steel frame
- Easy to clean and hygienic
- Ergonomic design
- Durable

GENEL ÖZELLİKLER

- Paslanmaz çelik yapı
- Kolay temizlenir ve hijyeniktir
- Ergonomik dizayn
- Uzun ömürlü

S6ST100

Dim(mm)LxDxH - Ebat (mm): 300x540x600
Gross Weight - Ağırlık : 7,5 kg
Gross Volume - Hacim : 0.10 m³
Price - Fiyat : 50 €



S6T150

Dim(mm)LxDxH - Ebat (mm): 450x540x600
Gross Weight - Ağırlık : 9 kg
Gross Volume - Hacim : 0.15 m³
Price - Fiyat : 60 €



S6ST200

Dim(mm)LxDxH - Ebat (mm): 600x540x600
Gross Weight - Ağırlık : 12 kg
Gross Volume - Hacim : 0.20 m³
Price - Fiyat : 76 €



KUSINA®

COOKING SERIES - PİŞİRİCİ SERİSİ

Series 600 • 600 Seri



Series 600 • Seri 600



GENERAL FEATURES

Kusina 600 serie is composed of modular equipments with electric and gas powers that meets the need of performance for operational work in small spaces.

This is a complete system for professional use designed with high thicknesses, durable, safety, efficiency, functionality.

600 serie is ideal choise for chefs looking for professional performance with compact desing in small rooms.

GENEL ÖZELLİKLER

Kusina 600 serisi küçük mutfaklar için elektrikli ve gazlı modüler kullanıma uygun , yüksek performanslı ürünler sunar.

Profesyonel kullanıma uygun, verimli fonksiyonel güvenli sağlam kalın sactan üretilmiş ürünlerdir.

Profesyonel şeflerin küçük mutfaklar için kullanabileceği yüksek performanslı ideal bir seridir.

GENERAL FEATURES

- Stainless steel body
- Quick easy cleaning
- Safety gas valve
- Ergonomic design
- Adjustable legs
- Durable

GENEL ÖZELLİKLER

- Paslanmaz çelik gövde
- Kolay temizlenebilir hijyenik
- Emniyet ventili gaz valfi
- Ergonomik tasarım
- Ayarlanabilir ayaklar
- Uzun ömürlü



G6K101G

Dim(mm)LxDxH - Ebat (mm):	400x600x300
Burner kW- Brülör kW	: 6,5
Power - Güç	: 6,5 kW
Gross Weight - Ağırlık	: 17 kg
Gross Volume - Hacim	: 0,18 m ³
Gas Inlet - Gaz Girişi	: R ½ "
Price - Fiyat	: 490 €



PRODUCT SPECIFICATIONS

- 2 or 4 Burners available
- High efficiency gas burner
- Heavy duty cooking grates

ÜRÜN DETAYLARI

- 2 veya 4 açık ateşli
- Yüksek verimli brülör
- Ağır kullanıma uygun ocak üst dökümleri

G6K100G 🔥

Dim(mm)LxDxH - Ebat (mm): 400x600x300
Burner kW- Brülör kW : 3,25 kW x 2
Power - Güç : 6,5 kW
Gross Weight - Ağırlık : 21 Kg
Gross Volume - Hacim : 0,18 m³
Gas Inlet - Gaz Girişi : R ½ "
Price - Fiyat : 401 €



G6K200G 🔥

Dim(mm)LxDxH - Ebat (mm): 600x600x300
Burner kW- Brülör kW : 3,25 kW x 4
Power - Güç : 13 kW
Gross Weight - Ağırlık : 32 Kg
Gross Volume - Hacim : 0,28 m³
Gas Inlet - Gaz Girişi : R ½ "
Price - Fiyat : 611 €



G6K203G 🔥

Dim(mm)LxDxH - Ebat (mm): 600x600x300
Burner kW- Brülör kW : 6,5 kW x 2
Power - Güç : 13 kW
Gross Weight - Ağırlık : 36 kg
Gross Volume - Hacim : 0,28 m³
Gas Inlet - Gaz Girişi : R ½ "
Price - Fiyat : 686 €



GENERAL FEATURES

- Stainless steel body
- Quick easy cleaning
- Safety gas valve
- Ergonomic design
- Adjustable legs
- Durable
- High power burners

GENEL ÖZELLİKLER

- Paslanmaz çelik gövde
- Kolay temizlenebilir hijyenik
- Emniyet ventili gaz valfi
- Ergonomik tasarım
- Ayarlanabilir ayaklar
- Uzun ömürlü
- Yüksek güçte brülörler

G6K100G-H 🔥

NEW

Dim(mm)LxDxH – Ebat (mm)	: 400x600x300
Burner kW- Brülör kW	: 6 kW x 2
Power - Güç	: 12 kW
Gross Weight - Ağırlık	: 21 Kg
Gross Volume - Hacim	: 0,18 m ³
Gas Inlet - Gaz Girişi	: R ½ "
Price - Fiyat	: 561 €



G6K200G-H 🔥

NEW

Dim(mm)LxDxH – Ebat (mm)	: 600x600x300
Burner kW- Brülör kW	: 6 kW x 4
Power - Güç	: 24 kW
Gross Weight - Ağırlık	: 32 Kg
Gross Volume - Hacim	: 0,28 m ³
Gas Inlet - Gaz Girişi	: R ½ "
Price - Fiyat	: 931 €



GENERAL FEATURES

- KUSINA induction products are committed to delivering more power, efficiency, stable and consistent performance.
- KUSINA takes induction technology to the next level with high controllability and reaction time that's as sleek as it is robust.
- For kitchens, these new induction ranges not only cooking like gas / electric, they exceed them.
- Impressive technology, power and reliability and control like nothing you have laid your hands on.

GENEL ÖZELLİKLER

- KUSINA indüksiyon ocakları daha fazla güç, verimli ve tutarlı performans sunmayı taahhüt etmektedir.
- KUSINA, sağlam olduğu kadar şık, yüksek kontrol edilebilirlik ve reaksiyon süresi ile indüksiyon teknolojisini bir üst seviye ye taşır.
- Yeni indüksiyon ocakları gazlı elektrikli ocaklar gibi sadece pişirmekle kalmaz, onların üstünde bir performans gösterir.
- Etkileyici teknoloji, güç, güvenilirlik ve daha önce deneyimlemediğiniz bir kontrol edebilirlik.

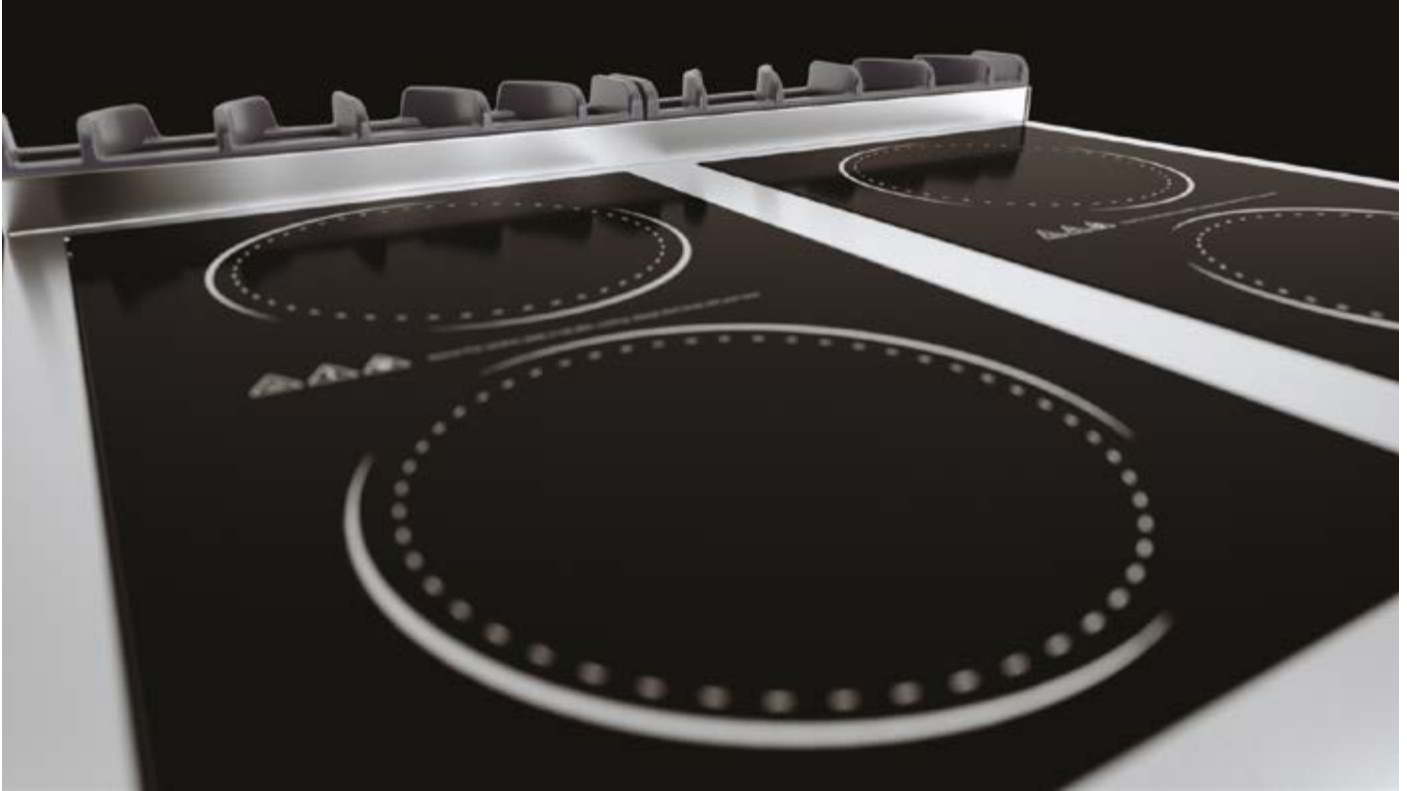

PRODUCT SPECIFICATIONS

- Very durable ceramic induction hobs
- Automatic overheating protection system
- Continuous runtime
- Seamless interaction with pan
- Stable / consistent performance
- Maximum controllability
- Reaction time less then 1 second
- High temperature cooking
- Effective isolation

ÜRÜN DETAYLARI

- Dayanıklı indüksiyon camları
- Yüksek sıcaklık koruma sistemi
- Kesintisiz çalışma sistemi
- Tava ile kesintisiz temas (etkileşim)
- Kararlı/ tutarlı performans
- Üst düzey kontrol edilebilirlik
- 1 saniyenin altında tepki süresi
- Yüksek sıcaklıkta pişirme
- Etkin yalıtım

GENERAL FEATURES

- Stainless steel body
- Quick easy cleaning
- Ergonomic design
- Adjustable legs
- Durable

GENEL ÖZELLİKLER

- Paslanmaz çelik gövde
- Kolay temizlenebilir hijyenik
- Ergonomik tasarım
- Ayarlanabilir ayaklar
- Uzun ömürlü

G6IN100E ⚡

Dim(mm)LxDxH - Ebat (mm): 400x600x300
Power - Güç : 3,5 kW
Gross Weight - Ağırlık : 30 kg
Gross Volume - Hacim : 0,18 m³
Electrical Inlet - Elektrik Girişi : 230 V N PE
Price - Fiyat : 1.975 €



G6IN200E ⚡

Dim(mm)LxDxH - Ebat (mm): 800x600x300
Power - Güç : 7 kW
Gross Weight - Ağırlık : 60 kg
Gross Volume - Hacim : 0,41 m³
Electrical Inlet - Elektrik Girişi : 400V 3N PE
Price - Fiyat : 3.800 €



GENERAL FEATURES

- Stainless steel body
- Quick easy cleaning
- Ergonomic design
- Adjustable legs
- Durable

GENEL ÖZELLİKLER

- Paslanmaz çelik gövde
- Kolay temizlenebilir hijyenik
- Ergonomik tasarım
- Ayarlanabilir ayaklar
- Dayanıklı

G6K100E ⚡

Dim(mm)LxDxH - Ebat (mm):	400x600x300
Plates - Isıtıcı Pleyt	: 2,0 kW x 2
Power - Güç	: 4 kW
Gross Weight - Ağırlık	: 18 kg
Gross Volume - Hacim	: 0,18 m ³
Electrical Inlet - Elektrik Girişi	: 230 V 1 N PE
Price - Fiyat	: 404 €



G6K200E ⚡

Dim(mm)LxDxH - Ebat (mm):	600x600x300
Plates - Isıtıcı Pleyt	: 2,0 kW x 4
Power - Güç	: 8 kW
Gross Weight - Ağırlık	: 28 Kg
Gross Volume - Hacim	: 0,28 m ³
Electrical Inlet - Elektrik Girişi	: 400 V 3 N PE
Price - Fiyat	: 622 €



PRODUCT SPECIFICATIONS

- 2 or 4 Ø 180 mm cooking plates
- Efficient fast heating
- Cooking plates available in 1850W
- Step temperature control

ÜRÜN DETAYLARI

- 2'li veya 4'lü Ø 180 mm pişirci pleyt
- Verimli hızlı pişirme
- Pleyt güçleri her biri 1850W
- Kademeli sıcaklık kontrolü

GENERAL FEATURES

- Stainless steel body
- Easy cleaning with movable resistances
- Ergonomic design
- Adjustable legs
- Durable
- Adjustable temperature control
- Safety Thermostat

GENEL ÖZELLİKLER

- Paslanmaz çelik gövde
- Hareketli rezistanslar ile kolay temizlenebilirlik
- Ergonomik tasarım
- Ayarlanabilir sıcaklık kontrolü
- Dayanıklı
- Ayarlanabilir ısı derecesi
- Emniyet termostatu

G6F100E ⚡

Dim(mm)LxDxH - Ebat (mm):	400x600x300
Power - Güç	: 7,5 kW
Gross Weight - Ağırlık	: 22 kg
Gross Volume - Hacim	: 0,18 m ³
Electrical Inlet - Elektrik Girişi	: 400 V 3N PE
Basket Size - Sepet Ölçüsü	: 195x245x130
Capacity - Kapasite	: 10 lt
Price - Fiyat	: 824 €



G6F100G 🔥

Dim(mm)LxDxH - Ebat (mm):	400x600x300
Power - Güç	: 6 kW
Gross Weight - Ağırlık	: 25 kg
Gross Volume - Hacim	: 0,18 m ³
Gas Inlet - Gaz Girişi	: R 1/2 "
Basket Size - Sepet Ölçüsü	: 195x290x90
Capacity - Kapasite	: 8 lt
Price - Fiyat	: 1.091 €



PRODUCT SPECIFICATIONS

- Single or double tank options
- Thermostat controlled heating
- Stainless steel baskets
- Operation and heating temperature control lights
- Operating temperature range (0-180 ° C)

ÜRÜN DETAYLARI

- Tekli veya çift havuzlu versiyonları
- Termostatik sıcaklık kontrolü
- Paslanmaz çelik sepetler
- Çalıştırma ve sıcaklık sinyal lambaları
- Çalışma ısı aralığı (0-180 ° C)

G6F200E ⚡

Dim(mm)LxDxH - Ebat (mm): 600x600x300
Power - Güç : 15 kW
Gross Weight - Ağırlık : 34 kg
Gross Volume - Hacim : 0,28 m³
Electrical Inlet - Elektrik Girişi : 400 V 3N PE
Basket Size - Sepet Ölçüsü : 195x245x130
Capacity - Kapasite : 2x10 lt
Price - Fiyat : 1.323 €

**G6F200G** 🔥

Dim(mm)LxDxH - Ebat (mm): 800x600x300
Power - Güç : 12 kW
Gross Weight - Ağırlık : 43 kg
Gross Volume - Hacim : 0,41 m³
Gas Inlet - Gaz Girişi : R ½ "
Basket Size - Sepet Ölçüsü : 195x290x90
Capacity - Kapasite : 2 x 8 lt
Price - Fiyat : 1.717 €



Chip Scuttle • Patates Dinlendirme

Series 600

GENERAL FEATURES

- Stainless steel body
- Quick easy cleaning
- Ergonomic design
- Adjustable legs
- Durable

GENEL ÖZELLİKLER

- Paslanmaz çelik gövde
- Kolay temizlenebilir hijyenik
- Ergonomik tasarım
- Ayarlanabilir ayaklar
- Uzun ömürlü

G6D100E ⚡

Dim(mm)LxDxH - Ebat (mm):	400x600x300
Power - Güç	: 1 kW
Gross Weight - Ağırlık	: 22 kg
Gross Volume - Hacim	: 0,18 m ³
Electrical Inlet - Elektrik Girişi	: 230 V N PE
Price - Fiyat	: 404 €



PRODUCT SPECIFICATIONS

- GN2/3 Container with oil strainer
- Ceramic infrared heater keeps fried potatoes at correct temperature

ÜRÜN DETAYLARI

- Yağ süzgeçli GN 2/3 patates haznesi
- Kızarmış patateslerin özel seramik infrared ısıtıcı ile sıcak kalması sağlanır

Sauce Bain Marie • Sos Benmari

GENERAL FEATURES

- Stainless steel body
- GN tubs not included
- Quick easy cleaning
- Well design according to GN
- Adjustable legs
- Durable

GENEL ÖZELLİKLER

- Paslanmaz çelik gövde
- GN küvetler dahil değildir
- Kolay temizlenebilir hijyenik
- GN küvetlere göre tasarlanmıştır
- Ayarlanabilir ayaklar
- Uzun ömürlü

G6S100E ⚡

Dim(mm)LxDxH - Ebat (mm):	400x600x300
Power - Güç	: 1 kW
Gross Weight - Ağırlık	: 20 kg
Gross Volume - Hacim	: 0,18 m ³
Electrical Inlet - Elektrik Girişi	: 230 V 1 N PE
Tank Capacity - Havuz Kapasitesi	: GN 1/2 150 mm x1 - GN 1/4 150 mm x 2
Price - Fiyat	: 491 €



Silver Series

Series 600

Series 700

Series 700S

Series 900

GENERAL FEATURES

- Stainless steel body
- Quick easy cleaning
- Stainless steel tube heaters
- Ergonomic design
- Adjustable legs
- Durable

G6M100E ⚡

Dim(mm)LxDxH - Ebat (mm):	400x600x300
Power - Güç	: 6 kW
Gross Weight - Ağırlık	: 20 kg
Gross Volume - Hacim	: 0,18 m ³
Electrical Inlet - Elektrik Girişi	: 400 V 3N PE
Basket Size - Sepet Ölçüsü	: 99x160x135(4pcs)
Capacity - Kapasite	: 10 lt
Price - Fiyat	: 794 €

PRODUCT SPECIFICATIONS

- Thermostat temperature control for safe operation
- On-off switch lights when reaching required temperature
- Operating temperature range (0-100 ° C)
- Manual water filling

Lavastone Griddle • Lav Taşlı Izgara

GENERAL FEATURES

- Stainless steel body
- Quick easy cleaning
- Gas valf with safety relief
- Ergonomic design
- Adjustable legs
- Durable

G6L200G 🔥

Dim(mm)LxDxH - Ebat (mm):	600x600x300
Power - Güç	: 8,5 kW
Gross Weight - Ağırlık	: 62 kg
Gross Volume - Hacim	: 0,28 m ³
Gas Inlet - Gaz Girişi	: R ½ "
Price - Fiyat	: 936 €

PRODUCT SPECIFICATIONS

- Heavy duty bottom cast iron griddle.
- Cooking surface with motion mechanism'
- Consistent cooking surface
- Stainless steel V-shape grilling grate
- Big capacity waste oil drawer
- Piezo spark ignition
- Sloped cooking surface for easy maintenance with drain
- High mineral pumice lava stones that trap heat for a long time

GENEL ÖZELLİKLER

- Paslanmaz çelik gövde
- Kolay temizlenebilir hijyenik
- Çelik borulu ısıtıcılar
- Ergonomik tasarım
- Ayarlanabilir ayaklar
- Uzun ömürlü



ÜRÜN DETAYLARI

- Çalışma ve termostatlı sıcaklık kontrolü
- Sıcaklığa ulaştığında açma-kapama ışıkları
- Çalışma ısı aralığı (0-100 ° C)
- Manuel su doldurma

GENEL ÖZELLİKLER

- Paslanmaz çelik gövde
- Kolay temizlenebilir hijyenik
- Emniyet ventili gaz valfi
- Ergonomik tasarım
- Ayarlanabilir ayaklar
- Uzun ömürlü



ÜRÜN DETAYLARI

- Demir dökümden yapılmış uzun ömürlü lavtası alt ızgarası
- Hareket mekanizmalı pişirme yüzeyi
- Homojen pişirme yüzeyi
- Çelik " v "şeklinde pişirme ızgarası
- Büyük kapasiteli atık yağ haznesi
- Piezoelektrik ateşlemeli brülör
- Kolay ve rahat temizlik için hafif eğimli pişirme yüzeyi, sıvı boşaltma delikli
- Isıyı uzun süre hapsedebilen, yüksek mineralli pomza lavtaşları

GENERAL FEATURES

- Stainless steel body
- Quick easy cleaning
- Safety gas valve
- Ergonomic design
- Adjustable legs
- Durable
- High efficiency burner
- Homogenous cooking surface
- Available lpg or natural gas

GENEL ÖZELLİKLER

- Paslanmaz çelik gövde
- Kolay temizlenebilir hijyenik
- Emniyet ventili gaz valfi
- Ergonomik tasarım
- Ayarlanabilir ayaklar
- Uzun ömürlü
- Yüksek verimli brülör
- Homojen pişirme yüzeyi
- Doğal gaz ve LPG ile çalışabilir



PRODUCT SPECIFICATIONS

- Top plates are available in smooth, ribbed or in combination.
- ST 52 Grade Steel Griddle or Chromium coated plates 12&15 mm thick.
- Sloped cooking surface for easy maintenance with liquid drain
- Consistent cooking surface
- Machined grooved plates
- Waste oil drawer
- Thermostat temperature control (Electrical)
- Easy cleaning with curved corners
- Insulated to prevent overheating and energy loss
- Operating temperature range (50-320 ° C)

ÜRÜN DETAYLARI

- Pişirme yüzeyinin düz, oluklu veya oluklu + düz versiyonları
- 12&15 mm kalınlığında ST 52 çelik veya krom kaplı çelik platina ızgaralar
- Pişirme yüzeyinin çevresi 3mm kalınlığında paslanmaz çelik
- Kolay ve rahat temizlik için hafif eğimli pişirme yüzeyi, sıvı boşaltma delikli
- Homojen ısınan pişirme yüzeyi
- Özel işlenmiş oluklar
- Atık yağ haznesi
- Termostatik sıcaklık kontrolü (Elektrikli ürünler için)
- Eğimli köşeler ile kolay temizlik
- Çevre saçlarının ısınması ve ısı kayıplarını minimum düzeye indiren izolasyon
- Çalışma ısısı aralığı (50-320 ° C)

G6I100E ⚡

Dim(mm)LxDxH - Ebat (mm): 400x600x300
 Power - Güç : 3 kW
 Gross Weight - Ağırlık : 41 kg
 Gross Volume - Hacim : 0,18 m³
 Smooth - Düz : 1/1
 Electrical Inlet - Elektrik Girişi : 400 V 3N PE
 Price - Fiyat : 682 €

**G6I110E** ⚡

Dim(mm)LxDxH - Ebat (mm): 400x600x300
 Power - Güç : 3 kW
 Gross Weight - Ağırlık : 47 kg
 Gross Volume - Hacim : 0,18m³
 Ribbed - Oluklu : 1/1
 Electrical Inlet - Elektrik Girişi : 400 V 3N PE
 Price - Fiyat : 851 €

**G6I200E** ⚡

Dim(mm)LxDxH - Ebat (mm): 600x600x300
 Power - Güç : 6 kW
 Gross Weight - Ağırlık : 51 kg
 Gross Volume - Hacim : 0,28 m³
 Smooth - Düz : 1/1
 Electrical Inlet - Elektrik Girişi : 400 V 3N PE
 Price - Fiyat : 968 €

**G6I200E-D** ⚡

DOUBLE ZONE CONTROL - ÇİFT BÖLGE KONTROL

Dim(mm)LxDxH - Ebat (mm): 600x600x300
 Power - Güç : 6 kW
 Gross Weight - Ağırlık : 52 kg
 Gross Volume - Hacim : 0,28 m³
 Smooth - Düz : 1/1
 Electrical Inlet - Elektrik Girişi : 400 V 3N PE
 Price - Fiyat : 1.040 €

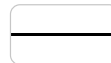

G6I210E ⚡

Dim(mm)LxDxH - Ebat (mm): 600x600x300
 Power - Güç : 6 kW
 Gross Weight - Ağırlık : 58 kg
 Gross Volume - Hacim : 0,28 m³
 Ribbed - Oluklu : 1/1
 Electrical Inlet - Elektrik Girişi : 400 V 3N PE
 Price - Fiyat : 1.192 €

**G6I210E-D** ⚡

DOUBLE ZONE CONTROL - ÇİFT BÖLGE KONTROL

Dim(mm)LxDxH - Ebat (mm): 600x600x300
 Power - Güç : 6 kW
 Gross Weight - Ağırlık : 59 kg
 Gross Volume - Hacim : 0,28 m³
 Ribbed - Oluklu : 1/1
 Electrical Inlet - Elektrik Girişi : 400 V 3N PE
 Price - Fiyat : 1.264 €

**G6I220E** ⚡

Dim(mm)LxDxH - Ebat (mm): 600x600x300
 Power - Güç : 6 kW
 Gross Weight - Ağırlık : 58 kg
 Gross Volume - Hacim : 0,28 m³
 Smooth - Düz : 1/2
 Ribbed - Oluklu : 1/2
 Electrical Inlet - Elektrik Girişi : 400 V 3N PE
 Price - Fiyat : 1.102 €

**G6I220E-D** ⚡

DOUBLE ZONE CONTROL - ÇİFT BÖLGE KONTROL

Dim(mm)LxDxH - Ebat (mm): 600x600x300
 Power - Güç : 6 kW
 Gross Weight - Ağırlık : 59 kg
 Gross Volume - Hacim : 0,28 m³
 Smooth - Düz : 1/2
 Ribbed - Oluklu : 1/2
 Electrical Inlet - Elektrik Girişi : 400 V 3N PE
 Price - Fiyat : 1.174 €

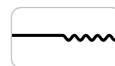

G6I100G 🔥

Dim(mm)LxDxH - Ebat (mm): 400x600x300
 Power - Güç : 5,8 kW
 Gross Weight - Ağırlık : 43 kg
 Gross Volume - Hacim : 0,18 m³
 Gas Inlet - Gaz Girişi : R ½ "
 Smooth - Düz : 1/1
 Price - Fiyat : 614 €



G6I110G 🔥

Dim(mm)LxDxH - Ebat (mm): 400x600x300
 Power - Güç : 5,8 kW
 Gross Weight - Ağırlık : 49 kg
 Gross Volume - Hacim : 0,18 m³
 Gas Inlet - Gaz Girişi : R ½ "
 Ribbed - Oluklu : 1/1
 Price - Fiyat : 726 €



G6I200G 🔥

Dim(mm)LxDxH - Ebat (mm): 600x600x300
 Power - Güç : 7,16 kW
 Gross Weight - Ağırlık : 53 kg
 Gross Volume - Hacim : 0,28 m³
 Gas Inlet - Gaz Girişi : R ½ "
 Smooth - Düz : 1/1
 Price - Fiyat : 758 €



G6I200G-D 🔥

DOUBLE ZONE CONTROL - ÇİFT BÖLGE KONTROL

Dim(mm)LxDxH - Ebat (mm): 600x600x300
 Power - Güç : 7,16 kW
 Gross Weight - Ağırlık : 53 kg
 Gross Volume - Hacim : 0,28 m³
 Gas Inlet - Gaz Girişi : R ½ "
 Smooth - Düz : 1/1
 Price - Fiyat : 914 €



G6I210G 

Dim(mm)LxDxH - Ebat (mm): 600x600x300
 Power - Güç : 7,16 kW
 Gross Weight - Ağırlık : 59 kg
 Gross Volume - Hacim : 0,28 m³
 Gas Inlet - Gaz Girişi : R ½ "
 Ribbed - Oluklu : 1/1
 Price - Fiyat : 870 €

**G6I210G-D** 

DOUBLE ZONE CONTROL - ÇİFT BÖLGE KONTROL

Dim(mm)LxDxH - Ebat (mm): 600x600x300
 Power - Güç : 7,16 kW
 Gross Weight - Ağırlık : 60 kg
 Gross Volume - Hacim : 0,28 m³
 Gas Inlet - Gaz Girişi : R ½ "
 Ribbed - Oluklu : 1/1
 Price - Fiyat : 1.026 €

**G6I220G** 

Dim(mm)LxDxH - Ebat (mm): 600x600x300
 Power - Güç : 7,16 kW
 Gross Weight - Ağırlık : 59 kg
 Gross Volume - Hacim : 0,28 m³
 Gas Inlet - Gaz Girişi : R ½ "
 Smooth - Düz : 1/2
 Ribbed - Oluklu : 1/2
 Price - Fiyat : 851 €

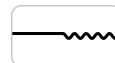
**G6I220G-D** 

DOUBLE ZONE CONTROL - ÇİFT BÖLGE KONTROL

Dim(mm)LxDxH - Ebat (mm): 600x600x300
 Power - Güç : 7,16 kW
 Gross Weight - Ağırlık : 60 kg
 Gross Volume - Hacim : 0,28 m³
 Gas Inlet - Gaz Girişi : R ½ "
 Smooth - Düz : 1/2
 Ribbed - Oluklu : 1/2
 Price - Fiyat : 1.007 €

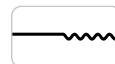

G6I100E-C ⚡

Dim(mm)LxDxH - Ebat (mm): 400x600x300
 Power - Güç : 3 kW
 Gross Weight - Ağırlık : 41 kg
 Gross Volume - Hacim : 0,18 m³
 Smooth - Düz : 1/1
 Chrome Plated - Krom Plate : 1/1
 Electrical Inlet - Elektrik Girişi : 400 V 3N PE
 Price - Fiyat : 934 €

**G6I110E-C** ⚡

Dim(mm)LxDxH - Ebat (mm): 400x600x300
 Power - Güç : 3 kW
 Gross Weight - Ağırlık : 47 kg
 Gross Volume - Hacim : 0,18m³
 Ribbed - Oluklu : 1/1
 Chrome Plated - Krom Plate : 1/1
 Electrical Inlet - Elektrik Girişi : 400 V 3N PE
 Price - Fiyat : 1.103 €

**G6I200E-C** ⚡

Dim(mm)LxDxH - Ebat (mm): 600x600x300
 Power - Güç : 6 kW
 Gross Weight - Ağırlık : 51 kg
 Gross Volume - Hacim : 0,28 m³
 Smooth - Düz : 1/1
 Chrome Plated - Krom Plate : 1/1
 Electrical Inlet - Elektrik Girişi : 400 V 3N PE
 Cooking Surface - Pişirme Yüzeyi : Chrome / Krom
 Price - Fiyat : 1.332 €

**G6I200E-CD** ⚡

DOUBLE ZONE CONTROL - ÇİFT BÖLGE KONTROL

Dim(mm)LxDxH - Ebat (mm): 600x600x300
 Power - Güç : 6 kW
 Gross Weight - Ağırlık : 52 kg
 Gross Volume - Hacim : 0,28 m³
 Smooth - Düz : 1/1
 Chrome Plated - Krom Plate : 1/1
 Electrical Inlet - Elektrik Girişi : 400 V 3N PE
 Cooking Surface - Pişirme Yüzeyi : Chrome / Krom
 Price - Fiyat : 1.404 €

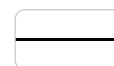

G6I210E-C ⚡

Dim(mm)LxDxH - Ebat (mm): 600x600x300
 Power - Güç : 6 kW
 Gross Weight - Ağırlık : 58 kg
 Gross Volume - Hacim : 0,28 m³
 Ribbed - Oluklu : 1/1
 Chrome Plated - Krom Plate : 1/1
 Electrical Inlet - Elektrik Girişi : 400 V 3N PE
 Price - Fiyat : 1.556 €



G6I210E-CD ⚡

DOUBLE ZONE CONTROL - ÇİFT BÖLGE KONTROL

Dim(mm)LxDxH - Ebat (mm): 600x600x300
 Power - Güç : 6 kW
 Gross Weight - Ağırlık : 59 kg
 Gross Volume - Hacim : 0,28 m³
 Ribbed - Oluklu : 1/1
 Chrome Plated - Krom Plate : 1/1
 Electrical Inlet - Elektrik Girişi : 400 V 3N PE
 Price - Fiyat : 1.628 €



G6I220E-C ⚡

Dim(mm)LxDxH - Ebat (mm): 600x600x300
 Power - Güç : 6 kW
 Gross Weight - Ağırlık : 58 kg
 Gross Volume - Hacim : 0,28 m³
 Smooth - Düz : 1/2
 Ribbed - Oluklu : 1/2
 Chrome Plated - Krom Plate : 1/1
 Electrical Inlet - Elektrik Girişi : 400 V 3N PE
 Price - Fiyat : 1.466 €



G6I220E-CD ⚡

DOUBLE ZONE CONTROL - ÇİFT BÖLGE KONTROL

Dim(mm)LxDxH - Ebat (mm): 600x600x300
 Power - Güç : 6 kW
 Gross Weight - Ağırlık : 59 kg
 Gross Volume - Hacim : 0,28 m³
 Smooth - Düz : 1/2
 Ribbed - Oluklu : 1/2
 Chrome Plated - Krom Plate : 1/1
 Electrical Inlet - Elektrik Girişi : 400 V 3N PE
 Price - Fiyat : 1.538 €

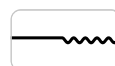

G6I100G-C 🔥

Dim(mm)LxDxH - Ebat (mm): 400x600x300
 Power - Güç : 5,8 kW
 Gross Weight - Ağırlık : 43 kg
 Gross Volume - Hacim : 0,18 m³
 Gas Inlet - Gaz Girişi : R ½ "
 Smooth - Düz : 1/1
 Chrome Plated - Krom Plate : 1/1
 Price - Fiyat : 866 €



G6I110G-C 🔥

Dim(mm)LxDxH - Ebat (mm): 400x600x300
 Power - Güç : 5,8 kW
 Gross Weight - Ağırlık : 49 kg
 Gross Volume - Hacim : 0,18 m³
 Gas Inlet - Gaz Girişi : R ½ "
 Ribbed - Oluklu : 1/1
 Chrome Plated - Krom Plate : 1/1
 Price - Fiyat : 978 €



G6I200G-C 🔥

Dim(mm)LxDxH - Ebat (mm): 600x600x300
 Power - Güç : 7,16 kW
 Gross Weight - Ağırlık : 53 kg
 Gross Volume - Hacim : 0,28 m³
 Gas Inlet - Gaz Girişi : R ½ "
 Smooth - Düz : 1/1
 Chrome Plated - Krom Plate : 1/1
 Price - Fiyat : 1.122 €



G6I200G-CD 🔥

DOUBLE ZONE CONTROL - ÇİFT BÖLGE KONTROL

Dim(mm)LxDxH - Ebat (mm): 600x600x300
 Power - Güç : 7,16 kW
 Gross Weight - Ağırlık : 54 kg
 Gross Volume - Hacim : 0,28 m³
 Gas Inlet - Gaz Girişi : R ½ "
 Smooth - Düz : 1/1
 Chrome Plated - Krom Plate : 1/1
 Price - Fiyat : 1.278 €

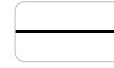

G6I210G-C 

Dim(mm)LxDxH - Ebat (mm): 600x600x300
 Power - Güç : 7,16 kW
 Gross Weight - Ağırlık : 59 kg
 Gross Volume - Hacim : 0,28 m³
 Ribbed - Oluklu : 1/1
 Chrome Plated - Krom Plate : 1/1
 Price - Fiyat : 1.234 €



G6I210G-CD 

DOUBLE ZONE CONTROL - ÇİFT BÖLGE KONTROL

Dim(mm)LxDxH - Ebat (mm): 600x600x300
 Power - Güç : 7,16 kW
 Gross Weight - Ağırlık : 60 kg
 Gross Volume - Hacim : 0,28 m³
 Ribbed - Oluklu : 1/1
 Chrome Plated - Krom Plate : 1/1
 Price - Fiyat : 1.390 €



G6I220G-C 

Dim(mm)LxDxH - Ebat (mm): 600x600x300
 Power - Güç : 7,16 kW
 Gross Weight - Ağırlık : 59 kg
 Gross Volume - Hacim : 0,28 m³
 Smooth - Düz : 1/2
 Ribbed - Oluklu : 1/2
 Chrome Plated - Krom Plate : 1/1
 Price - Fiyat : 1.215 €



G6I220G-CD 

DOUBLE ZONE CONTROL - ÇİFT BÖLGE KONTROL

Dim(mm)LxDxH - Ebat (mm): 600x600x300
 Power - Güç : 7,16 kW
 Gross Weight - Ağırlık : 60 kg
 Gross Volume - Hacim : 0,28 m³
 Smooth - Düz : 1/2
 Ribbed - Oluklu : 1/2
 Chrome Plated - Krom Plate : 1/1
 Price - Fiyat : 1.371 €



GENERAL FEATURES

- Stainless steel body
- Quick easy cleaning
- Ergonomic design
- Adjustable legs
- Durable

GENEL ÖZELLİKLER

- Paslanmaz çelik gövde
- Kolay temizlenebilir hijyenik
- Ergonomik tasarım
- Ayarlanabilir ayaklar
- Uzun ömürlü

G6T100N

Dim(mm)LxDxH - Ebat (mm): 400x600x300
Gross Weight - Ağırlık : 16 kg
Gross Volume - Hacim : 0,18 m³
Price - Fiyat : 219 €



G6T200N

Dim(mm)LxDxH - Ebat (mm): 600x600x300
Gross Weight - Ağırlık : 24 kg
Gross Volume - Hacim : 0,28 m³
Price - Fiyat : 251 €



GENERAL FEATURES

- Stainless steel body
- Easy to clean and hygienic
- Ergonomic design
- Adjustable legs
- Durable

GENEL ÖZELLİKLER

- Paslanmaz Çelik Gövde
- Kolay temizlenir ve hijyeniktir
- Ergonomik dizayn
- Ayarlanabilir ayaklar
- Uzun ömürlü

G6ST100-W

Dim(mm)LxDxH - Ebat (mm): 400x600x600
Gross Weight - Ağırlık : 14 kg
Gross Volume - Hacim : 0,18 m³
Price - Fiyat : 230 €



G6ST200-W

Dim(mm)LxDxH - Ebat (mm): 600x600x600
Gross Weight - Ağırlık : 19 kg
Gross Volume - Hacim : 0,28 m³
Price - Fiyat : 259 €



G6ST100-201

095.100.0022

G6ST200

095.100.0023

Features : Cabinet Door
Price- Fiyat : 55 €



GENERAL FEATURES

- Stainless steel body
- Easy to clean and hygienic
- Ergonomic design
- Adjustable legs
- Durable

GENEL ÖZELLİKLER

- Paslanmaz çelik gövde
- Kolay temizlenir ve hijyeniktir
- Ergonomik dizayn
- Ayarlanabilir ayaklar
- Uzun ömürlü

G6ST100

Dim(mm)LxDxH – Ebat (mm): 400x600x600
Gross Weight - Ağırlık : 16 kg
Gross Volume - Hacim : 0,19 m³
Price - Fiyat : 258 €



G6ST200

Dim(mm)LxDxH – Ebat (mm): 600x600x600
Gross Weight - Ağırlık : 26 kg
Gross Volume - Hacim : 0,34 m³
Price - Fiyat : 315 €



GENERAL FEATURES

- Stainless steel body
- Easy to clean and hygienic
- Ergonomic design
- Adjustable legs
- Long life

GENEL ÖZELLİKLER

- Paslanmaz çelik gövde
- Kolay temizlenir ve hijyeniktir
- Ergonomik dizayn
- Ayarlanabilir ayaklar
- Uzun yaşam

G6ST100C

Dim(mm)LxDxH - Ebat (mm): 400x600x600
Gross Weight - Ağırlık : 28 kg
Gross Volume - Hacim : 0,19 m³
Price - Fiyat : 998 €



G6ST200C

Dim(mm)LxDxH - Ebat (mm): 600x600x600
Gross Weight - Ağırlık : 40 kg
Gross Volume - Hacim : 0,34 m³
Price - Fiyat : 1.150 €



G6ST200C-800

Dim(mm)LxDxH - Ebat (mm): 800x600x600
Gross Weight - Ağırlık : 55 kg
Gross Volume - Hacim : 0,39 m³
Price - Fiyat : 1.252 €



KUSINA®

COOKING SERIES - PİŞİRİCİ SERİSİ

Series 700 • 700 Seri





GENERAL FEATURES

- Kusina 700 serie offers you medium size cooking equipments with the performance of bigger products.
- In 700 serie you can find full range of free standing and counter top models with flexibility and functionality.
- 700 serie is a smart professional solution for cafes, restaurants and hotels up to 300 meals per day.
- 700 serie desinged with high thicknesses, round shapes, easy cleaning removable trays and unscratchable washable grids.
- 700 serie is a high powered modular line with robustness, safety and ergonomics that fullfills all needs of professional chefs.
- The 700 serie produce with custom alloy resistances, 316 ss tank, hard-chromium cover, high quality components for long life.

GENEL ÖZELLİKLER

- Kusina 700 serisi, daha büyük serilerin sunduğu performansı , orta ölçekte sunar.
- 700 serisinde aranan tüm modeller esnek ve fonksiyonel olarak bulunur.
- Günde 300 yemek servisini aşmayan restoran otel ve kafeteryalar için 700 serisi çok akıllıca bir çözümdür.
- 700 serisi yıkanabilir yağadanlıkları , çizilmez dökümleri yuvarlatılmış hatları ve kalın saç kullanımı ile tasarlanıp üretilmiştir.
- 700 serisi SS316'dan üretilmiş havuzları , özel alaşımli ısıtıcıları , sert krom kaplaması ve yüksek kaliteli parçaları ile uzun ömürlü bir üründür.

GENERAL FEATURES

- Stainless steel body
- Quick easy cleaning
- Safety gas valve
- Ergonomic design
- Adjustable legs
- Durable
- High efficiency burner
- Insulated oven

GENEL ÖZELLİKLER

- Paslanmaz çelik gövde
- Kolay temizlenebilir hijyenik
- Emniyet ventili gaz valfi
- Ergonomik tasarım
- Ayarlanabilir ayaklar
- Uzun ömürlü
- Yüksek verimli brülör
- İzolasyonlu fırın



PRODUCT SPECIFICATIONS

- Available with 2, 4 or 6 burners, with or without oven
- Removable bottom burner tray for easy cleaning and maintenance
- Scratch resistant enamel coated cast iron top plates
- Nickel coated cast iron burners
- Protected Pilot Flame
- Available with oven or cabinet storage
- Position rack guides for 2/1 GN oven racks
- Oven constructed of aluminium coated sheet metal
- Stainless steel double-wall insulated door
- Self stabilizing flame
- Removable, easy clean stainless steel oven racks
- Thermostat temperature control with safety oven valve and thermocouple
- Piezo spark ignition
- Between 50-300°C temperature control is available, bottom and top heaters can be separately controlled

ÜRÜN DETAYLARI

- 2,4 ve 6 açık ateşli, fırınlı ve fırınsız modeller
- Kolay temizlik ve bakım-onarım sağlayan çıkarılabilir brülör alt tepsisi
- Emaye kaplı dökme demir çizilmez kolay temizlenebilir baca ve üst ızgara
- Dökme demir nikel kaplamalı ocakları
- Korumalı pilot alevi
- Fırınlı veya alt dolaplı
- Fırın içi GN 2/1 ölçülerine uygun
- Alüminize sacdan yapılmış fırın gövdesi
- Paslanmaz çelikten yapılmış çift cidarlı izolasyonlu kapak
- Stabilize ocak pilot alevleri
- Çıkarılabilir ve kolay temizlenebilir paslanmaz çelik fırın rafları
- Sıcaklık ayarlı termostatik emniyet valfli fırın gaz vanası
- Piezoelektrik ateşleme fırın pilotu.
- 50-300 °C arası sıcaklık kontrollü, alt ve üst ısıtıcıları ayrı ayrı kontrol etme imkanı

G7K100G-W 

Dim(mm)LxDxH - Ebat (mm):	400x730x900
Burners kW - Brülör kW	: 6,5 kW x 2
Power - Güç	: 13 kW
Gross Weight - Ağırlık	: 54 kg
Gross Volume - Hacim	: 0,46 m ³
Gas Inlet - Gaz Girişi	: R ½ "
Price - Fiyat	: 880 €



G7K100G 

Dim(mm)LxDxH - Ebat (mm):	400x730x900
Burners kW - Brülör kW	: 6,5 kW x 2
Power - Güç	: 13 kW
Gross Weight - Ağırlık	: 58 kg
Gross Volume - Hacim	: 0,46 m ³
Gas Inlet - Gaz Girişi	: R ½ "
Price - Fiyat	: 933 €



G7K101G-W 

Dim(mm)LxDxH - Ebat (mm): 400x730x900
Burners kW - Brülör kW : 6,5 kW
Power - Güç : 6,5 kW
Gross Weight - Ağırlık : 48 kg
Gross Volume - Hacim : 0,46 m³
Gas Inlet - Gaz Girişi : R ½ "
Price - Fiyat : 741 €



G7K101G 

Dim(mm)LxDxH - Ebat (mm): 400x730x900
Burners kW - Brülör kW : 6,5 kW
Power - Güç : 6,5 kW
Gross Weight - Ağırlık : 52 kg
Gross Volume - Hacim : 0,46 m³
Gas Inlet - Gaz Girişi : R ½ "
Price - Fiyat : 794 €



G7K200G-W 🔥

Dim(mm)LxDxH - Ebat (mm): 800x730x900
 Burners kW - Brülör kW : 6,5 kW x 4
 Power - Güç : 26 kW
 Gross Weight - Ağırlık : 87 kg
 Gross Volume - Hacim : 0,87 m³
 Gas Inlet - Gaz Girişi : R ½ "
 Price - Fiyat : 1.315 €



G7K200G 🔥

Dim(mm)LxDxH - Ebat (mm): 800x730x900
 Burners kW - Brülör kW : 6,5 kW x 4
 Power - Güç : 26 kW
 Gross Weight - Ağırlık : 95 kg
 Gross Volume - Hacim : 0,87 m³
 Gas Inlet - Gaz Girişi : R ½ "
 Price - Fiyat : 1.421 €



G7K201G-W 🔥

Dim(mm)LxDxH - Ebat (mm): 1200x730x900
 Burners kW - Brülör kW : 6,5 kW x 6
 Power - Güç : 39 kW
 Gross Weight - Ağırlık : 129 kg
 Gross Volume - Hacim : 1,44 m³
 Gas Inlet - Gaz Girişi : R ½ "
 Price - Fiyat : 1.743 €



G7K203G-W **NEW**

Dim(mm)LxDxH - Ebat (mm): 1600x730x900
 Burners kW -Brülör kW :6.5 kW x 8
 Power - Güç : 52 kW
 Gross Weight - Ağırlık : 160 kg
 Gross Volume - Hacim : 1,60 m³
 Gas Inlet - Gaz Girişi : R 1/2 " (2 pcs)
 Price - Fiyat : 2.791 €

**G7K203G** **NEW**

Dim(mm)LxDxH - Ebat (mm): 1600x730x900
 Burners kW -Brülör kW :6.5 kW x 8
 Power - Güç : 52 kW
 Gross Weight - Ağırlık : 176 kg
 Gross Volume - Hacim : 1,60 m³
 Gas Inlet - Gaz Girişi : R 1/2 " (2 pcs)
 Price - Fiyat : 2.995 €



G7K210G 

Dim(mm)LxDxH – Ebat (mm) :	800x730x900
Burners kW – Brülör kW :	6,5 kW x 4
Power – Güç :	32 kW
Gross Weight – Ağırlık :	143 kg
Gross Volume – Hacim :	0,87 m ³
Gas Inlet – Gaz Girişi :	R 1/2 "
Tray Dimensions – Tepsi boyutları :	GN 2/1x2
Oven kW – Fırın kW :	6 kW
Price – Fiyat :	2.067 €

**G7K213G** **NEW**

Dim(mm)LxDxH – Ebat (mm) :	1600x730x900
Burners kW – Brülör kW :	6.5 kW X 8
Power – Güç :	64 kW
Gross Weight – Ağırlık :	248 kg
Gross Volume – Hacim :	1,60 m ³
Gas Inlet – Gaz Girişi :	R 1/2 " (2 pcs)
Tray Dimensions – Tepsi boyutları :	GN2/1 X 4
Oven kW – Fırın kW :	6 kW x 2
Price – Fiyat :	3.310 €



G7K201G 

Dim(mm)LxDxH - Ebat (mm):	1200x730x900
Burners kW - Brülör kW	: 6,5 kW x 6
Power - Güç	: 39 kW
Gross Weight - Ağırlık	: 143 kg
Gross Volume - Hacim	: 1,44 m ³
Gas Inlet - Gaz Girişi	: R ½ "
Price - Fiyat	: 1.908 €

**G7K211G-W** 

Dim(mm)LxDxH - Ebat (mm):	1200x730x900
Burners kW - Brülör kW	: 6,5 kW x 6
Power - Güç	: 45 kW
Gross Weight - Ağırlık	: 187,5 kg
Gross Volume - Hacim	: 1,44 m ³
Gas Inlet - Gaz Girişi	: R ½ "
Tray Dimensions - Tepsi boyutları	: GN2/1 x 2
Oven kW - Fırın kW	: 6 kW
Price - Fiyat	: 2.567 €



G7K211G 🔥

Dim(mm)LxDxH - Ebat (mm):	1200x730x900
Burners kW - Brülör kW	: 6,5 kW x 6
Power - Güç	: 45 kW
Gross Weight - Ağırlık	: 191,5 kg
Gross Volume - Hacim	: 1,44 m ³
Gas Inlet - Gaz Girişi	: R ½ "
Tray Dimensions - Tepsi boyutları:	GN 2/1x2
Oven kW - Fırın kW	: 6 kW
Price - Fiyat	: 2.620 €

**G7K212G** 🔥

Dim(mm)LxDxH - Ebat (mm):	1200x730x900
Burners kW - Brülör kW	: 6,5 kW x 6
Power - Güç	: 46 kW
Gross Weight - Ağırlık	: 206 kg
Gross Volume - Hacim	: 1,44 m ³
Gas Inlet - Gaz Girişi	: R ½ "
Oven kW - Fırın kW	: 10 kW
Tray Dimensions - Tepsi boyutları:	900x590x65 mm
Price - Fiyat	: 3.209 €



G7K201G-KD 🔥

Dim(mm)LxDxH – Ebat (mm) :	1200x730x900
Power-Güç :	32,9 kW
Burners kW – Brülör kW :	6,5 kW x 5
Gross Weight -Ağırlık :	129 kg
Gross Volume - Hacim :	1,44 m ³
Gas Inlet – Gaz Girişi :	R 1/2 "
Price - Fiyat :	2.540 €



G7K211G-KD 🔥

Dim(mm)LxDxH – Ebat (mm) :	1200x730x900
Power-Güç :	39,5 kW
Burners kW – Brülör kW :	6,5 kW x 5
Gross Weight -Ağırlık :	175 kg
Gross Volume - Hacim :	1,44 m ³
Gas Inlet – Gaz Girişi :	R 1/2 "
Tray Dimensions – Tepsi boyutları :	GN 2/1x2
Oven kW – Fırın kW :	6 kW
Price - Fiyat :	3.254 €



G7K212G-KD 🔥

Dim(mm)LxDxH – Ebat (mm) :	1200x730x900
Power-Güç :	40,5 kW
Burners kW – Brülör kW :	6,5 kW x 5
Gross Weight -Ağırlık :	195 kg
Gross Volume - Hacim :	1,44 m ³
Gas Inlet – Gaz Girişi :	R 1/2 "
Tray Dimensions – Tepsi boyutları :	900x590x65 mm – 2 pcs
Oven kW – Fırın kW :	10 kW
Price - Fiyat :	4.067 €



GENERAL FEATURES

- 4 open flame, 1 close flame burner, with or without oven
- Easy to clean and simple maintenance with removable burner bottom tray.
- Unscratchable and enameled cast iron top grates.
- Nickel coated cast iron burners.
- Protected pilot flame.
- With oven or cupboards.
- Oven available for 2/1 GN trays.
- The body of the oven is made of aluminium coated sheet metal.
- Stainless steel double-wall, insulated door
- Self stabilizing flame.
- Removable and easy to clean stainless steel oven shelves.
- Thermostatic temperature control with safety valve and thermocouple.
- Piezo-electric burner ignition

ÜRÜN DETAYLARI

- 4 açık ateş, 1 kapalı ateş brülörlü ve fırınlı fırınsız modeller
- Kolay temizlik ve bakım-onarım sağlayan çıkarılabilir brülör alt tepsi
- Emaye kaplı dökme demir çizilmez kolay temizlenebilir baca ve üst ızgara
- Dökme demir nikel kaplamalı ocakları
- Korumalı pilot alevi
- Fırınlı veya alt dolaplı
- Fırın içi GN 2/1 ölçülerine uygun
- Alüminize sacdan yapılmış fırın gövdesi
- Paslanmaz çelikten yapılmış çift cidarlı izolasyonlu kapak
- Stabilize ocak pilot alevleri.
- Çıkarılabilir ve kolay temizlenebilir paslanmaz çelik fırın rafları
- Sıcaklık ayarlı termostatik emniyet valfli fırın gaz vanası
- Piezoelektrik ateşleme fırın pilotu.

G7K220G 🔥

Dim(mm)LxDxH - Ebat (mm): 800x730x900
Power-Güç : 5 kW
Gross Weight -Ağırlık : 135 kg
Gross Volume - Hacim : 0,87 m³
Gas Inlet - Gaz Girişi : R ½ "
Price - Fiyat : 1.028 €



G7K221G 🔥

Dim(mm)LxDxH - Ebat (mm): 800x730x900
Power-Güç : 11 kW
Gross Weight - Ağırlık : 130 kg
Gross Volume - Hacim : 0,87 m³
Gas Inlet - Gaz Girişi : R ½ "
Tray Dimensions - Tepsi boyutları : GN 2/1x2
Oven kW - Fırın kW : 6 kW
Price - Fiyat : 1.743 €



GENERAL FEATURES

- KUSINA induction products are committed to delivering more power, efficiency, stable and consistent performance.
- KUSINA takes induction technology to the next level with high controllability and reaction time that's as sleek as it is robust.
- For kitchens, these new induction ranges not only cooking like gas / electric, they exceed them.
- Impressive technology, power and reliability and control like nothing you have laid your hands on.

GENEL ÖZELLİKLER

- KUSINA indüksiyon ocakları daha fazla güç, verimli ve tutarlı performans sunmayı taahhüt etmektedir.
- KUSINA, sağlam olduğu kadar şık, yüksek kontrol edilebilirlik ve reaksiyon süresi ile indüksiyon teknolojisini bir üst seviye ye taşır.
- Yeni indüksiyon ocakları gazlı elektrikli ocaklar gibi sadece pişirmekle kalmaz, onların üstünde bir performans gösterir.
- Etkileyici teknoloji, güç, güvenilirlik ve daha önce deneyimlemediğiniz bir kontrol edebilirlik.



PRODUCT SPECIFICATIONS

- Very durable ceramic induction hobs
- Automatic overheating protection system
- Continuous runtime
- Seamless interaction with pan
- Stable / consistent performance
- Maximum controllability
- Reaction time less then 1 second
- High temperature cooking
- Effective isolation

ÜRÜN DETAYLARI

- Dayanıklı indüksiyon camları
- Yüksek sıcaklık koruma sistemi
- Kesintisiz çalışma sistemi
- Tava ile kesintisiz temas (etkileşim)
- Kararlı/ tutarlı performans
- Üst düzey kontrol edilebilirlik
- 1 saniyenin altında tepki süresi
- Yüksek sıcaklıkta pişirme
- Etkin yalıtım

GENERAL FEATURES

- Stainless steel body
- Quick easy cleaning
- Ergonomic design
- Adjustable legs
- Durable

GENEL ÖZELLİKLER

- Paslanmaz çelik gövde
- Kolay temizlenebilir hijyenik
- Ergonomik tasarım
- Ayarlanabilir ayaklar
- Uzun ömürlü

G7IN100E-W ⚡

Dim(mm)LxDxH - Ebat (mm): 400x730x900
Power - Güç : 7 kW
Gross Weight - Ağırlık : 32 kg
Gross Volume - Hacim : 0,46 m³
Electrical Inlet - Elektrik Girişi : 400V 3N PE
Price - Fiyat : 4.400 €



G7IN200E-W ⚡

Dim(mm)LxDxH - Ebat (mm): 800x730x900
Power - Güç : 14 kW
Gross Weight - Ağırlık : 53 kg
Gross Volume - Hacim : 0,87 m³
Electrical Inlet - Elektrik Girişi : 400V 3N PE
Price - Fiyat : 8.348 €



G7WIN100E-W ⚡

Dim(mm)LxDxH - Ebat (mm): 400x730x900
Power - Güç : 5 kW
Gross Weight - Ağırlık : 44 kg
Gross Volume - Hacim : 0,46 m³
Electrical Inlet - Elektrik Girişi : 230 V 1N PE
Price - Fiyat : 4.363 €



GENERAL FEATURES

- Stainless steel body
- Quick easy cleaning
- Ergonomic design
- Adjustable legs
- Durable

GENEL ÖZELLİKLER

- Paslanmaz çelik gövde
- Kolay temizlenebilir hijyenik
- Ergonomik tasarım
- Ayarlanabilir ayaklar
- Uzun ömürlü

G7IN100E ⚡

Dim(mm)LxDxH - Ebat (mm): 400x730x900
Power - Güç : 7 kW
Gross Weight - Ağırlık : 36 kg
Gross Volume - Hacim : 0,46 m³
Electrical Inlet - Elektrik Girişi : 400V 3N PE
Price - Fiyat : 4.455 €



G7IN200E ⚡

Dim(mm)LxDxH - Ebat (mm): 800x730x900
Power - Güç : 14 kW
Gross Weight - Ağırlık : 57 kg
Gross Volume - Hacim : 0,87 m³
Electrical Inlet - Elektrik Girişi : 400V 3N PE
Price - Fiyat : 8.458 €



G7WIN100E ⚡

Dim(mm)LxDxH - Ebat (mm): 400x730x900
Power - Güç : 5 kW
Gross Weight - Ağırlık : 48 kg
Gross Volume - Hacim : 0,46 m³
Electrical Inlet - Elektrik Girişi : 230 V 1N PE
Price - Fiyat : 4.418 €



GENERAL FEATURES

- Stainless steel body
- Quick easy cleaning
- Ergonomic design
- Adjustable legs
- Durable
- Insulated oven

GENEL ÖZELLİKLER

- Paslanmaz çelik gövde
- Kolay temizlenebilir hijyenik
- Ergonomik tasarım
- Ayarlanabilir ayaklar
- Uzun ömürlü
- İzolasyonlu fırın



PRODUCT SPECIFICATIONS

- 2 or 4 heating plates, with or without oven models
- Ø 180 mm and Ø 230 mm -two types of cooking plates
- Scratch-prooff enamel coated cast iron back grate.
- With oven or cupboards oven or storage cabinet
- Position rack guides for 2/1 GN racks
- Oven constructed of aluminium coated sheet metal
- Stainless steel double-wall, insulated door
- Adjustable temperature level control

ÜRÜN DETAYLARI

- 2,4 ve ısıtıcı pleytli, fırınlı ve fırınsız modeller
- Ø 180 VE Ø 230 mm olmak üzere iki çeşit pişirme pleyti
- Çizilmez ve paslanmaz emaye dökme demir baca
- Fırınlı veya alt dolaplı
- Fırın içi GN 2/1 ölçülerine uygun
- Alüminize sacdan yapılmış fırın gövdesi
- Paslanmaz çelikten yapılmış çift cidarlı izolasyonlu kapı
- Kademeli sıcaklık kontrolü

G7K100E-W ⚡

Dim(mm)LxDxH - Ebat (mm):	400x730x900
Plates - Isıtıcı Pleyt	: 2,0 kW x 1 - 2,6 kW x 1
Power - Güç	: 4,6 kW
Gross Weight - Ağırlık	: 46,5 kg
Gross Volume - Hacim	: 0,46 m ³
Electrical Inlet - Elektrik Girişi	: 400V 3N PE
Price - Fiyat	: 667 €

**G7K100E** ⚡

Dim(mm)LxDxH - Ebat (mm):	400x730x900
Plates - Isıtıcı Pleyt	: 2,0 kW x 1 - 2,6 kW x 1
Power - Güç	: 4,6 kW
Gross Weight - Ağırlık	: 50,5 kg
Gross Volume - Hacim	: 0,46 m ³
Electrical Inlet - Elektrik Girişi	: 400V 3N PE
Price - Fiyat	: 720 €



G7K200E-W ⚡

Dim(mm)LxDxH - Ebat (mm): 800x730x900
 Plates - Isıtıcı Pleyt : 2,0 kW x 2 - 2,6 kW x 2
 Power - Güç : 9,2 kW
 Gross Weight - Ağırlık : 76 kg
 Gross Volume - Hacim : 0,87 m³
 Electrical Inlet - Elektrik Girişi : 400 V 3N PE
 Price - Fiyat : 1.004 €



G7K200E ⚡

Dim(mm)LxDxH - Ebat (mm): 800x730x900
 Plates - Isıtıcı Pleyt : 2,0 kW x 2 - 2,6 kW x 2
 Power - Güç : 9,2 kW
 Gross Weight - Ağırlık : 84 kg
 Gross Volume - Hacim : 0,87 m³
 Electrical Inlet - Elektrik Girişi : 400 V 3N PE
 Price - Fiyat : 1.110 €



G7K210E ⚡

Dim(mm)LxDxH - Ebat (mm): 800x730x900
 Plates - Isıtıcı Pleyt : 2,0 kW x 2 - 2,6 kW x 2
 Power - Güç : 15,2 kW
 Gross Weight - Ağırlık : 126 kg
 Gross Volume - Hacim : 0,87 m³
 Electrical Inlet - Elektrik Girişi : 400 V 3N PE
 Tray Dimensions - Tepsi boyutları : GN 2/1x2
 Oven - Fırın : 6 kW
 Price - Fiyat : 1.882 €



GENERAL FEATURES

- Stainless steel body
- Quick easy cleaning
- Ergonomic design
- Adjustable legs
- Durable

GENEL ÖZELLİKLER

- Paslanmaz çelik gövde
- Kolay temizlenebilir hijyenik
- Ergonomik tasarım
- Ayarlanabilir ayaklar
- Uzun ömürlü

G7K201E-W ⚡

Dim(mm)LxDxH - Ebat (mm):	1200x730x900
Plates - Isıtıcı Pleyt	: 2,0 kW x 3 - 2,6 kW x 3
Power - Güç	: 13,8 kW
Gross Weight - Ağırlık	: 113 kg
Gross Volume - Hacim	: 1,44 m ³
Electrical Inlet - Elektrik Girişi	: 400 V 3N PE
Price - Fiyat	: 1.365 €



G7K201E ⚡

Dim(mm)LxDxH - Ebat (mm):	1200x730x900
Plates - Isıtıcı Pleyt	: 2,0 kW x 3 - 2,6 kW x 3
Power - Güç	: 13,8 kW
Gross Weight - Ağırlık	: 125 kg
Gross Volume - Hacim	: 1,44 m ³
Electrical Inlet - Elektrik Girişi	: 400 V 3N PE
Price - Fiyat	: 1.512 €



PRODUCT SPECIFICATIONS THERMAL HOT PLATES

- Available 6 heating plates, with or without oven
- Ø 180 mm and Ø 230 mm - two types of cooking plates
- Scratch-proff enamel coated cast iron back grate.

ÜRÜN DETAYLARI TERMİKLİ HOT PLEYTLER

- 6 ısıtıcı pleytli, fırınlı ve fırınlı modeller
- Ø 180 VE Ø 230 mm olmak üzere iki çeşit pişirme pleyti
- Çizilmez ve paslanmaz emaye dökme demir baca

GENERAL FEATURES

- Stainless steel body
- Quick easy cleaning
- Ergonomic design
- Adjustable legs
- Durable

GENEL ÖZELLİKLER

- Paslanmaz çelik gövde
- Kolay temizlenebilir hijyenik
- Ergonomik tasarım
- Ayarlanabilir ayaklar
- Uzun ömürlü

G7K211E-W ⚡

Dim(mm)LxDxH - Ebat (mm):	1200x730x900
Power - Güç	: 19,8 kW
Plates-Isıtıcı Pleyt	: 2,0 kW x 3 - 2,6 kW x 3
Gross Weight - Ağırlık	: 168 kg
Gross Volume - Hacim	: 1,44 m ³
Electrical Inlet - Elektrik Girişi	: 400 V 3N PE
Tray Dimensions - Tepsi boyutları	: GN2/1x2
Oven - Fırın	: 6 kW
Price - Fiyat	: 2.180 €



G7K211E ⚡

Dim(mm)LxDxH - Ebat (mm):	1200x730x900
Plates - Isıtıcı Pleyt	: 2,0 kW x 3 - 2,6 kW x 3
Power - Güç	: 19,8 kW
Gross Weight - Ağırlık	: 172 kg
Gross Volume - Hacim	: 1,44 m ³
Electrical Inlet - Elektrik Girişi	: 400 V 3N PE
Tray Dimensions - Tepsi boyutları	: GN2/1x2
Oven - Fırın	: 6 kW
Price - Fiyat	: 2.233 €



G7K212E ⚡

Dim(mm)LxDxH – Ebat (mm)	: 1200x730x900
Plates – Isıtıcı Pleyt	: 2,0 kW x 3 – 2,6 kW x 3
Power – Güç	: 22,8 kW
Gross Weight – Ağırlık	: 175 kg
Gross Volume – Hacim	: 1,44 m ³
Electrical Inlet – Elektrik Girişi	: 400 V 3N PE
Tray Dimensions – Tepsi boyutları	: 900x590x65 mm-2 pcs
Oven – Fırın	: 9 KW
Price – Fiyat	: 2.365 €

**PRODUCT SPECIFICATIONS THERMAL HOT PLATES**

- Available 6 heating plates, with or without oven
- Ø 180 mm and Ø 230 mm -two types of cooking plates
- Scratch-proff enamel coated cast iron back grate.

ÜRÜN DETAYLARI TERMİKLİ HOT PLEYTLER

- 6 ısıtıcı pleytli, fırınlı ve fırınlı modeller
- Ø 180 VE Ø 230 mm olmak üzere iki çeşit pişirme pleyti
- Çizilmez ve paslanmaz emaye dökme demir baca

G7K100E-K-W ⚡

Dim(mm)LxDxH - Ebat (mm): 400x730x900
Plates - Isıtıcı Pleyt : 2,6 kW x 2
Power - Güç : 5,2 kW
Gross Weight - Ağırlık : 49 kg
Gross Volume - Hacim : 0,46 m³
Electrical Inlet - Elektrik Girişi : 400V 3N PE
Price - Fiyat : 928 €



G7K100E-K ⚡

Dim(mm)LxDxH - Ebat (mm): 400x730x900
Plates - Isıtıcı Pleyt : 2,6 kW x 2
Power - Güç : 5,2 kW
Gross Weight - Ağırlık : 53 kg
Gross Volume - Hacim : 0,46 m³
Electrical Inlet - Elektrik Girişi : 400V 3N PE
Price - Fiyat : 983 €



G7K200E-K-W ⚡

Dim(mm)LxDxH - Ebat (mm): 800x730x900
 Plates - Isıtıcı Pleyt : 2,6 kW x 4
 Power - Güç : 10,4 kW
 Gross Weight - Ağırlık : 90 kg
 Gross Volume - Hacim : 0,87 m³
 Electrical Inlet - Elektrik Girişi : 400V 3N PE
 Price - Fiyat : 1.477 €

**G7K200E-K** ⚡

Dim(mm)LxDxH - Ebat (mm): 800x730x900
 Plates - Isıtıcı Pleyt : 2,6 kW x 4
 Power - Güç : 10,4 kW
 Gross Weight - Ağırlık : 98 kg
 Gross Volume - Hacim : 0,87 m³
 Electrical Inlet - Elektrik Girişi : 400V 3N PE
 Price - Fiyat : 1.596 €

**G7K210E-K** ⚡

Dim(mm)LxDxH - Ebat (mm): 800x730x900
 Plates - Isıtıcı Pleyt : 2,6 kW x 4
 Power - Güç : 16,4 kW
 Gross Weight - Ağırlık : 136 kg
 Gross Volume - Hacim : 0,87 m³
 Electrical Inlet - Elektrik Girişi : 400V 3N PE
 Tray Dimensions - Tepsi boyutları : GN 2/1x2
 Oven - Fırın : 6 kW
 Price - Fiyat : 2.461 €



GENERAL FEATURES

- Stainless steel body
- Quick easy cleaning
- Ergonomic design
- Adjustable legs
- Durable

GENEL ÖZELLİKLER

- Paslanmaz çelik gövde
- Kolay temizlenebilir hijyenik
- Ergonomik tasarım
- Ayarlanabilir ayaklar
- Uzun ömürlü

G7K201E-K-W ⚡

Dim(mm)LxDxH - Ebat (mm):	1200x730x900
Plates - Isıtıcı Pleyt	: 2,6 kW x 6
Power - Güç	: 15,6 kW
Gross Weight - Ağırlık	: 134 kg
Gross Volume - Hacim	: 1,44 m ³
Electrical Inlet - Elektrik Girişi	: 400V 3N PE
Price - Fiyat	: 2.058 €



G7K201E-K ⚡

Dim(mm)LxDxH - Ebat (mm):	1200x730x900
Plates - Isıtıcı Pleyt	: 2x6kW x 6
Power - Güç	: 15,6 kW
Gross Weight - Ağırlık	: 146 kg
Gross Volume - Hacim	: 1,44 m ³
Electrical Inlet - Elektrik Girişi	: 400V 3N PE
Price - Fiyat	: 2.223 €



PRODUCT SPECIFICATIONS

- Available 6 heating plates, with or without oven
- 20x220mm thermally square plate
- Scratch-proff enamel coated cast iron back grate.

ÜRÜN DETAYLARI

- 6 ısıtıcı pleytli, fırınlı ve fırınlı modeller
- 220x220mm termikli kare pleyt
- Çizilmez ve paslanmaz emaye dökme demir baca

GENERAL FEATURES

- Stainless steel body
- Quick easy cleaning
- Ergonomic design
- Adjustable legs
- Durable

GENEL ÖZELLİKLER

- Paslanmaz çelik gövde
- Kolay temizlenebilir hijyenik
- Ergonomik tasarım
- Ayarlanabilir ayaklar
- Uzun ömürlü

G7K211E-K-W ⚡

Dim(mm)LxDxH - Ebat (mm):	1200x730x900
Plates - Isıtıcı Pleyt	: 2,6 kW x 6
Power - Güç	: 21,6 kW
Gross Weight - Ağırlık	: 189 kg
Gross Volume - Hacim	: 1,44 m ³
Electrical Inlet - Elektrik Girişi	: 400V 3N PE
Tray Dimensions - Tepsi boyutları	: GN 2/1x2
Oven - Fırın	: 6 kW
Price - Fiyat	: 2.971 €



G7K211E-K ⚡

Dim(mm)LxDxH - Ebat (mm):	1200x730x900
Plates - Isıtıcı Pleyt	: 2,6 kW x 6
Power - Güç	: 21,6 kW
Gross Weight - Ağırlık	: 193 kg
Gross Volume - Hacim	: 1,44 m ³
Electrical Inlet - Elektrik Girişi	: 400V 3N PE
Tray Dimensions - Tepsi boyutları	: GN 2/1x2
Oven - Fırın	: 6 kW
Price - Fiyat	: 3.030 €



G7K212E-K ⚡

Dim(mm)LxDxH – Ebat (mm)	: 1200x730x900
Plates – Isıtıcı Pleyt	: 2,6 kW x 6
Power – Güç	: 24,6 kW
Gross Weight – Ağırlık	: 196 kg
Gross Volume – Hacim	: 1,44 m ³
Electrical Inlet – Elektrik Girişi	: 400V 3N PE
Tray Dimensions – Tepsi boyutları	: 900x590x65 mm – 2 pcs
Oven – Fırın	: 9 kW
Price – Fiyat	: 3.178 €

**PRODUCT SPECIFICATIONS**

- Available 6 heating plates, with or without oven
- Ø 180 mm and Ø 230 mm – two types of cooking plates
- Scratch-proff enamel coated cast iron back grate.

ÜRÜN DETAYLARI

- 6 ısıtıcı pleytli, fırınlı ve fırınlı modeller
- Ø 180 VE Ø 230 mm olmak üzere iki çeşit pişirme pleyti
- Çizilmez ve paslanmaz emaye dökme demir baca

GENERAL FEATURES

- Stainless steel body
- Quick easy cleaning
- Safety Thermostat
- Ergonomic design
- Adjustable legs
- Durable
- Single or double cooking tanks

GENEL ÖZELLİKLER

- Paslanmaz çelik gövde
- Kolay temizlenebilir hijyenik
- Emniyet termostati
- Ergonomik tasarım
- Ayarlanabilir ayaklar
- Uzun ömürlü
- Tekli ve Çiftli Havuz



PRODUCT SPECIFICATIONS

- Indicator light when reaching required temperature
- Well designed avoid to overflow
- Operating temperature range (0-100 ° C) electric thermostatic control
- 316 SS quality tank
- 304 SS quality baskets
- Special alloy resistances
- heaters with incoloy material
- water filling battery
- magneto ignition system (gas)
- safety gas valve (gas)
- stainless burner (gas)
- baskets not included

ÜRÜN DETAYLARI

- Gerekli sıcaklığa ulaştığından yanan gösterge ışıkları
- Taşmayı önleyici tasarım
- Çalışma ısısı aralığı (0-100 ° C) elektrikli termostatik kontrol
- 316 SS kalite havuz
- 304 SS kalite sepetler
- Özel alaşım rezistanslar
- incoloy malzemeli ısıtıcılar
- su doldurma bataryası
- manyetolu ateşleme sistemi (gazlı)
- emniyetli gaz valfi (gazlı)
- paslanmaz brülör (gazlı)
- sepetler dahil değildir

G7M100E ⚡

Dim(mm)LxDxH - Ebat (mm): 400x730x900
 Power - Güç : 9 kW
 Gross Weight - Ağırlık : 54,5 kg
 Gross Volume - Hacim : 0,46 m³
 Electrical Inlet - Elektrik Girişi : 400 V 3N PE
 Capacity - Kapasite : 18 lt
 Basket Size - Sepet Ölçüsü : 220X165X210 (1 pcs) 110X165X210 (2 pcs)
 Price - Fiyat : 1.252 €



G7M100G 🔥

Dim(mm)LxDxH - Ebat (mm): 400x730x900
 Power - Güç : 10,5 kW
 Gross Weight - Ağırlık : 79 kg
 Gross Volume - Hacim : 0,46 m³
 Gas Inlet - Gaz Girişi : R ½ "
 Capacity - Kapasite : 18 lt
 Basket Size - Sepet Ölçüsü : 220X165X240 (1 pcs) 110X165X240 (2 pcs)
 Price - Fiyat : 1.233 €



G7M200E ⚡

Dim(mm)LxDxH - Ebat (mm): 800x730x900
 Power - Güç : 18 kW
 Gross Weight - Ağırlık : 110 kg
 Gross Volume - Hacim : 0,87 m³
 Electrical Inlet - Elektrik Girişi : 400 V 3N PE
 Capacity - Kapasite : 2 x 18 lt
 Basket Size - Sepet Ölçüsü : 220x165x210 (2 PCS) 110x165x210 (4 PCS)
 Price - Fiyat : 1.860 €



GENERAL FEATURES

- Stainless steel body
- Quick easy cleaning
- Safety gas valve
- Ergonomic design
- Adjustable legs
- Durable
- High efficiency burner
- Available lpg or natural gas

GENEL ÖZELLİKLER

- Paslanmaz çelik gövde
- Kolay temizlenebilir hijyenik
- Emniyet ventili gaz valfi
- Ergonomik tasarım
- Ayarlanabilir ayaklar
- Uzun ömürlü
- Yüksek verimli brülör
- Doğal gaz ve LPG ile çalışabilir



PRODUCT SPECIFICATIONS

- Top plates available in smooth, ribbed or combination plates
- Fry top with storage cabinet
- 12-15mm thick griddle plate in ST 52 steel, or hard chromium coated steel
- 3 mm thickness splash guard
- Stainless steel oil collection drawer is placed in cupboard cabinet.
- Sloped cooking surface for easy maintenance with drain
- Consistent heating cooking surface
- Machined grooved plates
- Large sized draining drawer
- Thermostat temperature control (electrical)
- Thermocouple safety device connected to the burner
- Piezo spark ignition double independent cooking surface
- Insulated to prevent overheating and energy loss
- Round corners to easy proper cleaning

ÜRÜN DETAYLARI

- Pişirme yüzeyinin düz, oluklu veya oluklu+düz versiyonları
- Izgara altı kapaklı dolap
- 15 mm kalınlığında st 52 çelik veya sert krom kaplı çelik platina ızgaralar
- Pişirme yüzeyinin çevresi 3mm kalınlığında paslanmaz çelik
- Dolap içerisine yerleştirilmiş paslanmaz çelik yağ toplama çekmecesini
- Kolay ve rahat temizlik için hafif eğimli pişirme yüzeyi
- Homojen ısınan pişirme yüzeyi
- Özel işlenmiş oluklar
- Büyük hacimli boşaltma çekmecesini
- Termostatik sıcaklık kontrolü (Elektrikli Ürünlerde)
- Brülöre bağlı termokupl emniyet sistemi
- Piezoelektrik ateşlemeli brülör bir veya iki bağımsız pişirme bölgesi versiyonları
- Çevre saçlarının ısınması ve ısı kayıplarını minimum düzeye indiren izolasyon
- Yuvarlatılmış köşe tasarımı ile kolay temizlik

G7I 100E-W ⚡

Dim(mm)LxDxH - Ebat (mm): 400x730x900
 Power - Güç : 3,6 kW
 Gross Weight - Ağırlık : 72 kg
 Gross Volume - Hacim : 0,46 m³
 Smooth - Düz : 1/1
 Electrical Inlet - Elektrik Girişi : 400 V 3N PE
 Price - Fiyat : 896 €

**G7I 100E** ⚡

Dim(mm)LxDxH - Ebat (mm): 400x730x900
 Power - Güç : 3,6 kW
 Gross Weight - Ağırlık : 76 kg
 Gross Volume - Hacim : 0,46 m³
 Smooth - Düz : 1/1
 Electrical Inlet - Elektrik Girişi : 400 V 3N PE
 Price - Fiyat : 949 €

**G7I 110E-W** ⚡

Dim(mm)LxDxH - Ebat (mm): 400x730x900
 Power - Güç : 3,6 kW
 Gross Weight - Ağırlık : 80 kg
 Gross Volume - Hacim : 0,46 m³
 Electrical Inlet - Elektrik Girişi : 400 V 3N PE
 Ribed - Oluklu : 1/1
 Price - Fiyat : 1.120 €



G7I 110E ⚡

Dim(mm)LxDxH - Ebat (mm) : 400x730x900
 Power - Güç : 3,6 kW
 Gross Weight - Ağırlık : 84 kg
 Gross Volume - Hacim : 0,46 m³
 Ribed - Oluklu : 1/1
 Electrical Inlet - Elektrik Girişi : 400 V 3N PE
 Price - Fiyat : 1.173 €

**G7I 200E-W** ⚡

Dim(mm)LxDxH - Ebat (mm) : 800x730x900
 Power - Güç : 7,2 kW
 Gross Weight - Ağırlık : 127 kg
 Gross Volume - Hacim : 0,87 m³
 Smooth - Düz : 1/1
 Electrical Inlet - Elektrik Girişi : 400 V 3N PE
 Price - Fiyat : 1.353 €

**G7I 200E** ⚡

Dim(mm)LxDxH - Ebat (mm) : 800x730x900
 Power - Güç : 7,2 kW
 Gross Weight - Ağırlık : 135 kg
 Gross Volume - Hacim : 0,87 m³
 Smooth - Düz : 1/1
 Electrical Inlet - Elektrik Girişi : 400 V 3N PE
 Price - Fiyat : 1.459 €



G7I 210E-W ⚡

Dim(mm)LxDxH - Ebat (mm) : 800x730x900
 Power - Güç : 7,2 kW
 Gross Weight - Ağırlık : 135 kg
 Gross Volume - Hacim : 0,87 m³
 Ribed - Oluklu : 1/1
 Electrical Inlet - Elektrik Girişi : 400 V 3N PE
 Price - Fiyat : 1.677 €

**G7I 210E** ⚡

Dim(mm)LxDxH - Ebat (mm) : 800x730x900
 Power - Güç : 7,2 kW
 Gross Weight - Ağırlık : 143 kg
 Gross Volume - Hacim : 0,87 m³
 Ribed - Oluklu : 1/1
 Electrical Inlet - Elektrik Girişi : 400 V 3N PE
 Price - Fiyat : 1.783 €

**G7I 220E-W** ⚡

Dim(mm)LxDxH - Ebat (mm) : 800x730x900
 Power - Güç : 7,2 kW
 Gross Weight - Ağırlık : 135 kg
 Gross Volume - Hacim : 0,87 m³
 Smooth - Düz : 1/2
 Ribed - Oluklu : 1/2
 Electrical Inlet - Elektrik Girişi : 400 V 3N PE
 Price - Fiyat : 1.454 €



G7I 220E ⚡

Dim(mm)LxDxH - Ebat (mm): 800x730x900
 Power - Güç : 7,2 kW
 Gross Weight - Ağırlık : 143 kg
 Gross Volume - Hacim : 0,87 m³
 Smooth - Düz : 1/2
 Ribed - Oluklı : 1/2
 Electrical Inlet - Elektrik Girişi : 400 V 3N PE
 Price - Fiyat : 1.560 €

**G7I 100G-W** 🔥

Dim(mm)LxDxH - Ebat (mm): 400x730x900
 Power - Güç : 6,5 kW
 Gross Weight - Ağırlık : 68 kg
 Gross Volume - Hacim : 0,46 m³
 Gas Inlet - Gaz Girişi : R 1/2 "
 Smooth - Düz : 1/1
 Price - Fiyat : 861 €

**G7I 100G** 🔥

Dim(mm)LxDxH - Ebat (mm): 400x730x900
 Power - Güç : 6,5 kW
 Gross Weight - Ağırlık : 72 kg
 Gross Volume - Hacim : 0,46 m³
 Gas Inlet - Gaz Girişi : R 1/2 "
 Smooth - Düz : 1/1
 Price - Fiyat : 914 €



G7I 110G-W 

Dim(mm)LxDxH – Ebat (mm) : 400x730x900
 Power - Güç : 6,5 kW
 Gross Weight - Ağırlık : 76 kg
 Gross Volume - Hacim : 0,46 m³
 Gas Inlet - Gaz Girişi : R ½ "
 Ribed - Oluklu : 1/1
 Price - Fiyat : 1.109 €

**G7I 110G** 

Dim(mm)LxDxH – Ebat (mm) : 400x730x900
 Power - Güç : 6,5 kW
 Gross Weight - Ağırlık : 80 kg
 Gross Volume - Hacim : 0,46 m³
 Gas Inlet - Gaz Girişi : R ½ "
 Ribed - Oluklu : 1/1
 Price - Fiyat : 1.162 €

**G7I 200G-W** 

Dim(mm)LxDxH – Ebat (mm) : 800x730x900
 Power - Güç : 13 kW
 Gross Weight - Ağırlık : 110 kg
 Gross Volume - Hacim : 0,87 m³
 Gas Inlet - Gaz Girişi : R ½ "
 Smooth - Düz : 1/1
 Price - Fiyat : 1.222 €



G7I 200G 

Dim(mm)LxDxH - Ebat (mm): 800x730x900
 Power - Güç : 13 kW
 Gross Weight - Ağırlık : 118 kg
 Gross Volume - Hacim : 0,87 m³
 Gas Inlet - Gaz Girişi : R ½ "
 Smooth - Düz : 1/1
 Price - Fiyat : 1.328 €

**G7I 210G-W** 

Dim(mm)LxDxH - Ebat (mm): 800x730x900
 Power - Güç : 13 kW
 Gross Weight - Ağırlık : 116 kg
 Gross Volume - Hacim : 0,87 m³
 Gas Inlet - Gaz Girişi : R ½ "
 Ribed - Oluklu : 1/1
 Price - Fiyat : 1.634 €

**G7I 210G** 

Dim(mm)LxDxH - Ebat (mm): 800x730x900
 Power - Güç : 13 kW
 Gross Weight - Ağırlık : 124 kg
 Gross Volume - Hacim : 0,87 m³
 Gas Inlet - Gaz Girişi : R ½ "
 Ribed - Oluklu : 1/1
 Price - Fiyat : 1.740 €



G7I 220G-W 

Dim(mm)LxDxH - Ebat (mm): 800x730x900
Power - Güç : 13 kW
Gross Weight - Ağırlık : 116 kg
Gross Volume - Hacim : 0,87 m³
Gas Inlet - Gaz Girişi : R ½ "
Smooth - Düz : 1/2
Ribed - Oluklu : 1/2
Price - Fiyat : 1.405 €

**G7I 220G** 

Dim(mm)LxDxH - Ebat (mm): 800x730x900
Power - Güç : 13 kW
Gross Weight - Ağırlık : 124 kg
Gross Volume - Hacim : 0,87 m³
Gas Inlet - Gaz Girişi : R ½ "
Smooth - Düz : 1/2
Ribed - Oluklu : 1/2
Price - Fiyat : 1.511 €



G7I100E-C-W ⚡

Dim(mm)LxDxH - Ebat (mm): 400x730x900
 Power - Güç : 3,6 kW
 Gross Weight - Ağırlık : 72 kg
 Gross Volume - Hacim : 0,46 m³
 Smooth - Düz : 1/1
 Chrome Plated - Krom Plate : 1/1
 Electrical Inlet - Elektrik Girişi : 400 V 3N PE
 Price - Fiyat : 1.165 €

**G7I100E-C** ⚡

Dim(mm)LxDxH - Ebat (mm): 400x730x900
 Power - Güç : 3,6 kW
 Gross Weight - Ağırlık : 76 kg
 Gross Volume - Hacim : 0,46 m³
 Smooth - Düz : 1/1
 Chrome Plated - Krom Plate : 1/1
 Electrical Inlet - Elektrik Girişi : 400 V 3N PE
 Price - Fiyat : 1.218 €

**G7I110E-C-W** ⚡

Dim(mm)LxDxH - Ebat (mm): 400x730x900
 Power - Güç : 3,6 kW
 Gross Weight - Ağırlık : 80 kg
 Gross Volume - Hacim : 0,45 m³
 Electrical Inlet - Elektrik Girişi : 400 V 3N PE
 Ribed - Oluklu : 1/1
 Chrome Plated - Krom Plate : 1/1
 Price - Fiyat : 1389 €



G7I110E-C ⚡

Dim(mm)LxDxH - Ebat (mm): 400x730x900
 Power - Güç : 3,6 kW
 Gross Weight - Ağırlık : 84 kg
 Gross Volume - Hacim : 0,46 m³
 Electrical Inlet - Elektrik Girişi : 400 V 3N PE
 Ribed - Oluklu : 1/1
 Chrome Plated - Krom Plate : 1/1
 Price - Fiyat : 1.442 €



G7I 200E-C-W ⚡

Dim(mm)LxDxH - Ebat (mm): 800x730x900
 Power - Güç : 7,2 kW
 Gross Weight - Ağırlık : 127 kg
 Gross Volume - Hacim : 0,87 m³
 Smooth - Düz : 1/1
 Chrome Plated - Krom Plate : 1/1
 Electrical Inlet - Elektrik Girişi : 400 V 3N PE
 Price - Fiyat : 1.832 €



G7I 200E-C ⚡

Dim(mm)LxDxH - Ebat (mm): 800x730x900
 Power - Güç : 7,2 kW
 Gross Weight - Ağırlık : 135 kg
 Gross Volume - Hacim : 0,87 m³
 Electrical Inlet - Elektrik Girişi : 400 V 3N PE
 Smooth - Düz : 1/1
 Chrome Plated - Krom Plate : 1/1
 Price - Fiyat : 1.938 €



G7I 210E-C-W ⚡

Dim(mm)LxDxH - Ebat (mm): 800x730x900
 Power - Güç : 7,2 kW
 Gross Weight - Ağırlık : 135 kg
 Gross Volume - Hacim : 0,87 m³
 Ribed - Oluklu : 1/1
 Chrome Plated - Krom Plate : 1/1
 Electrical Inlet - Elektrik Girişi : 400 V 3N PE
 Price - Fiyat : 2.156 €

**G7I 210E-C** ⚡

Dim(mm)LxDxH - Ebat (mm): 800x730x900
 Power - Güç : 7,2 kW
 Gross Weight - Ağırlık : 143 kg
 Gross Volume - Hacim : 0,87 m³
 Electrical Inlet - Elektrik Girişi : 400 V 3N PE
 Ribed - Oluklu : 1/1
 Chrome Plated - Krom Plate : 1/1
 Price - Fiyat : 2.262 €

**G7I 220E-C-W** ⚡

Dim(mm)LxDxH - Ebat (mm): 800x730x900
 Power - Güç : 7,2 kW
 Gross Weight - Ağırlık : 135 kg
 Gross Volume - Hacim : 0,87 m³
 Smooth - Düz : 1/2
 Ribed - Oluklu : 1/2
 Chrome Plated - Krom Plate : 1/1
 Electrical Inlet - Elektrik Girişi : 400 V 3N PE
 Price - Fiyat : 1.933 €



G7I 220E-C ⚡

Dim(mm)LxDxH - Ebat (mm): 800x730x900
 Power - Güç : 7,2 kW
 Gross Weight - Ağırlık : 143 kg
 Gross Volume - Hacim : 0,87 m³
 Smooth - Düz : 1/2
 Ribed - Oluklu : 1/2
 Chrome Plated - Krom Plate : 1/1
 Electrical Inlet - Elektrik Girişi : 400 V 3N PE
 Price - Fiyat : 2.039 €



G7I 100G-C-W 🔥

Dim(mm)LxDxH - Ebat (mm): 400x730x900
 Power - Güç : 6,5 kW
 Gross Weight - Ağırlık : 68 kg
 Gross Volume - Hacim : 0,46 m³
 Smooth - Düz : 1/1
 Chrome Plated - Krom Plate : 1/1
 Gas Inlet - Gaz Girişi : R ½ "
 Price - Fiyat : 1.130 €



G7I 100G-C 🔥

Dim(mm)LxDxH - Ebat (mm): 400x730x900
 Power - Güç : 6,5 kW
 Gross Weight - Ağırlık : 72 kg
 Gross Volume - Hacim : 0,46 m³
 Gas Inlet - Gaz Girişi : R ½ "
 Smooth - Düz : 1/1
 Chrome Plated - Krom Plate : 1/1
 Price - Fiyat : 1.183 €



G7I 110G-C-W 🔥

Dim(mm)LxDxH - Ebat (mm): 400x730x900
 Power - Güç : 6,5 kW
 Gross Weight - Ağırlık : 76 kg
 Gross Volume - Hacim : 0,46 m³
 Ribed - Oluklu : 1/1
 Chrome Plated - Krom Plate : 1/1
 Gas Inlet - Gaz Girişi : R ½ "
 Price - Fiyat : 1.378 €



G7I 110G-C 🔥

Dim(mm)LxDxH - Ebat (mm): 400x730x900
 Power - Güç : 6,5 kW
 Gross Weight - Ağırlık : 80 kg
 Gross Volume - Hacim : 0,46 m³
 Gas Inlet - Gaz Girişi : R ½ "
 Ribed - Oluklu : 1/1
 Chrome Plated - Krom Plate : 1/1
 Price - Fiyat : 1.431 €



G7I 200G-C-W 🔥

Dim(mm)LxDxH - Ebat (mm): 800x730x900
 Power - Güç : 13 kW
 Gross Weight - Ağırlık : 110 kg
 Gross Volume - Hacim : 0,87 m³
 Gas Inlet - Gaz Girişi : R ½ "
 Smooth - Düz : 1/1
 Chrome Plated - Krom Plate : 1/1
 Price - Fiyat : 1.701 €



G7I 200G-C 

Dim(mm)LxDxH - Ebat (mm): 800x730x900
 Power - Güç : 13 kW
 Gross Weight - Ağırlık : 118 kg
 Gross Volume - Hacim : 0,87 m³
 Gas Inlet - Gaz Girişi : R ½ "
 Smooth - Düz : 1/1
 Chrome Plated - Krom Plate : 1/1
 Price - Fiyat : 1.807 €



G7I 210G-C-W 

Dim(mm)LxDxH - Ebat (mm): 800x730x900
 Power - Güç : 13 kW
 Gross Weight - Ağırlık : 116 kg
 Gross Volume - Hacim : 0,87 m³
 Gas Inlet - Gaz Girişi : R ½ "
 Ribed - Oluklu : 1/1
 Chrome Plated - Krom Plate : 1/1
 Price - Fiyat : 2.113 €



G7I 210G-C 

Dim(mm)LxDxH - Ebat (mm): 800x730x900
 Power - Güç : 13 kW
 Gross Weight - Ağırlık : 124 kg
 Gross Volume - Hacim : 0,87 m³
 Gas Inlet - Gaz Girişi : R ½ "
 Ribed - Oluklu : 1/1
 Chrome Plated - Krom Plate : 1/1
 Price - Fiyat : 2.219 €



G7I 220G-C-W 

Dim(mm)LxDxH - Ebat (mm) :	800x730x900
Power - Güç :	13 kW
Gross Weight - Ağırlık :	116 kg
Gross Volume - Hacim :	0,87 m ³
Gas Inlet - Gaz Girişi :	R ½ "
Smooth - Düz :	1/2
Ribed - Oluklu :	1/2
Chrome Plated - Krom Plate :	1/1
Price - Fiyat :	1.884 €

**G7I 220G-C** 

Dim(mm)LxDxH - Ebat (mm) :	800x730x900
Power - Güç :	13 kW
Gross Weight - Ağırlık :	124 kg
Gross Volume - Hacim :	0,87 m ³
Gas Inlet - Gaz Girişi :	R ½ "
Smooth - Düz :	1/2
Ribed - Oluklu :	1/2
Chrome Plated - Krom Plate :	1/1
Price - Fiyat :	1.990 €



GENERAL FEATURES

- Stainless steel body
- Well clean with movable resistances
- Ergonomic design
- Adjustable legs
- Durable
- High efficiency burner

GENEL ÖZELLİKLER

- Paslanmaz çelik gövde
- Hareketli rezistanslar ile kolay temizlenebilirlik
- Ergonomik tasarım
- Ayarlanabilir ayaklar
- Dayanıklı
- Yüksek verimli brülör

G7F100E ⚡

Dim(mm)LxDxH - Ebat (mm):	400x730x900
Power - Güç	: 14 kW
Gross Weight - Ağırlık	: 57 kg
Gross Volume - Hacim	: 0,46 m ³
Electrical Inlet - Elektrik Girişi	: 400 V 3N PE
Basket Size - Sepet Ölçüsü	: 140x235x185mm (2 pcs)
Capacity - Kapasite	: 18 lt
Price - Fiyat	: 1.227 €



G7F100G 🔥

Dim(mm)LxDxH - Ebat (mm):	400x730x900
Power - Güç	: 13,8 kW
Gross Weight - Ağırlık	: 71 kg
Gross Volume - Hacim	: 0,49 m ³
Gas Inlet - Gaz Girişi	: R ½ "
Basket Size - Sepet Ölçüsü	: 140x280x130 (2 pcs)
Capacity - Kapasite	: 15 lt
Price - Fiyat	: 1.456 €



PRODUCT SPECIFICATIONS

- Single or double tanks models
- Scratch-proof and enameled cast iron back grate
- Fryer with storage cabinet
- Piezo spark ignition
- Thermostat temperature control
- Stainless steel baskets
- Adjustable temperature
- High efficient gas combustion system
- Operation and heating control indicator lights
- Stainless steel tube heaters (For electrical products)

ÜRÜN DETAYLARI

- Tekli veya çift havuzlu modelleri
- Çizilmez ve paslanmaz emaye dökme demir baca
- Kapaklı alt dolap
- Piezoelektrik ateşlemeli brülör
- Termostatlı sıcaklık kontrolü
- Paslanmaz sepetler
- Ayarlanabilir ısı derecesi
- Yüksek verim sağlayan gaz yanış sistemi
- Çalıştırma ve sıcaklık sinyal lambaları
- Paslanmaz boru rezistans (Elektrikli ürünler için)

G7F110E ⚡**NEW**

Dim(mm)LxDxH - Ebat (mm):	400x730x900
Power - Güç	: 7,5 kW
Gross Weight - Ağırlık	: 53 kg
Gross Volume - Hacim	: 0,46 m ³
Electrical Inlet - Elektrik Girişi	: 400 V 3N PE
Basket Size - Sepet Ölçüsü	: 200x260x115 mm (1 pcs)
Capacity - Kapasite	: 10 lt
Price - Fiyat	: 1.195 €

**G7F210E** ⚡

Dim(mm)LxDxH - Ebat (mm):	800x730x900
Power - Güç	: 15 kW
Gross Weight - Ağırlık	: 87 kg
Gross Volume - Hacim	: 0,87 m ³
Electrical Inlet - Elektrik Girişi	: 400 V 3N PE
Basket Size - Sepet Ölçüsü	: 200x260x115 (2pcs)
Capacity - Kapasite	: 2x10 lt
Price - Fiyat	: 1.858 €

**PRODUCT SPECIFICATIONS**

- Scratch-proof and enameled cast iron back grate
- Fryer with storage cabinet
- Thermostatic temperature control
- Stainless steel baskets
- Adjustable temperature
- Special alloy resistances
- Operation and heating control indicator lights

ÜRÜN DETAYLARI

- Çizilmez ve paslanmaz emaye dökme demir baca
- Kapaklı alt dolap
- Termostatlı sıcaklık kontrolü
- Paslanmaz sepetler
- Ayarlanabilir sıcaklık derecesi
- Özel alaşım rezistanslar
- Çalıştırma ve sıcaklık sinyal lambaları

G7F200E ⚡

Dim(mm)LxDxH - Ebat (mm): 800x730x900
Power - Güç : 28 kW
Gross Weight - Ağırlık : 91 kg
Gross Volume - Hacim : 0,87 m³
Electrical Inlet - Elektrik Girişi : 400 V 3N PE
Basket Size - Sepet Ölçüsü : 140x235x185 mm (4 pcs)
Capacity - Kapasite : 2x 18 lt
Price - Fiyat : 1.991 €

**G7F200G** 🔥

Dim(mm)LxDxH - Ebat (mm): 800x730x900
Power - Güç : 27.6 kW
Gross Weight - Ağırlık : 121 kg
Gross Volume - Hacim : 0,89 m³
Gas Inlet - Gaz Girişi : R ½ "
Basket Size - Sepet Ölçüsü : 140x280x130 (4 pcs)
Capacity - Kapasite : 2x15 lt
Price - Fiyat : 2.394 €



GENERAL FEATURES

- Stainless steel body
- Quick easy cleaning
- Ergonomic design
- Adjustable legs
- Durable

GENEL ÖZELLİKLER

- Paslanmaz çelik gövde
- Kolay temizlenebilir hijyenik
- Ergonomik tasarım
- Ayarlanabilir ayaklar
- Uzun ömürlü

G7TD200E ⚡

Dim(mm)LxDxH - Ebat (mm)	: 800x730x900
Power - Güç	: 9 kW
Gross Weight - Ağırlık	: 140 kg
Gross Volume - Hacim	: 0,87 m ³
Electrical Inlet - Elektrik Girişi	: 400 V 3N PE
Capacity - Kapasite	: 60 lt
Price - Fiyat	: 2.882 €



G7TD200G ⚡

Dim(mm)LxDxH - Ebat (mm)	: 800x730x900
Power - Güç	: 20,5 kW
Gross Weight - Ağırlık	: 149 kg
Gross Volume - Hacim	: 0,87 m ³
Electrical Inlet - Elektrik Girişi	: 230V 1N PE - 50-60 hz
Gas Inlet - Gaz Girişi	: R 1/2 "
Capacity - Kapasite	: 60 lt
Price - Fiyat	: 3.097 €



PRODUCT SPECIFICATIONS

- Stainless steel cooking pan
- Safety switch activates, when the tilting starts
- Safety thermostat
- Pilot light and valve with thermocouple
- Piezo spark ignition
- Water fill pipe controlled from front panel
- 200 mm depth stainless steel pan
- Scratch-proof enamel coated cast iron back grate
- Thermostat temperature control
- Tubular burner under tank
- Adjustable heating system 50°C - 300°C
- Manual boost system

ÜRÜN DETAYLARI

- Paslanmaz pişirme kazanı.
- Pişirme kazanı kaldırıldığında çalışmayı durduran emniyet şalter
- Emniyet termostadı.
- Pilot alevi ve termokupullu valf
- Piezoelektrik ateşlemeli brülör
- Ön panelden kontrol edilen su doldurma borusu
- Havuz derinliği 200 mm
- Çizilmez ve paslanmaz emaye dökme demir baca
- Termostatik sıcaklık kontrolü
- Pişirme havuzu altında paslanmaz boru ısıtıcılar
- Ayarlanabilir sıcaklık, 50°C - 300°C
- Volanlı manuel kaldırma

GENERAL FEATURES

- Stainless steel body
- Quick easy cleaning
- Ergonomic design
- Adjustable legs
- Durable

GENEL ÖZELLİKLER

- Paslanmaz çelik gövde
- Kolay temizlenebilir hijyenik
- Ergonomik tasarım
- Ayarlanabilir ayaklar
- Uzun ömürlü

G7KT200E-C ⚡

Dim(mm)LxDxH - Ebat (mm): 800x730x900

Power - Güç : 6 kw

Gross Weight - Ağırlık : 115,5 kg

Gross Volume - Hacim : 0,87 m³

Electrical Inlet - Elektrik Girişi : 400V 3N PE

Capacity - Kapasite : 60 lt

Price - Fiyat : 3.450 €



PRODUCT SPECIFICATIONS

- Water inlet and drain taps located on front panel
- Direct or indirect heating
- Durable and minimum maintenance provided by using oil in jacket
- High efficiency and minimum maintenance indirect heating
- Safety thermostat
- Safety discharge valve

ÜRÜN DETAYLARI

- Su doldurma musluğu ve tahliye vanası
- Direkt veya indirekt ısıtma
- Ceketler arasında kullanılan yağ sayesinde minimum bakım ve uzun ömür
- Yüksek verim sağlayan yağlı indirekt ısıtma
- Emniyet termostatu
- Emniyetli boşaltma vanası

GENERAL FEATURES

- Stainless steel body
- Easy to clean and hygienic
- Ergonomic design
- Adjustable legs
- Durable
- Casting suitable for special wok pan

GENEL ÖZELLİKLER

- Paslanmaz çelik gövde
- Kolay temizlenebilir hijyenik
- Ergonomik tasarım
- Ayarlanabilir ayaklar
- Uzun ömürlü
- Özel wok tavaına uygun dökümler

G7W100G-W

Dim(mm)LxDxH - Ebat (mm):	400x730x900
Power - Güç	: 15 kW
Gross Weight - Ağırlık	: 63 kg
Gross Volume - Hacim	: 0,46 m ³
Gas Inlet - Gaz Girişi	: R ½ "
Price - Fiyat	: 800 €



G7W100G

Dim(mm)LxDxH - Ebat (mm):	400x730x900
Power - Güç	: 15 kW
Gross Weight - Ağırlık	: 67 kg
Gross Volume - Hacim	: 0,46 m ³
Gas Inlet - Gaz Girişi	: R ½ "
Price - Fiyat	: 853 €



PRODUCT SPECIFICATIONS

- Iron cast burners, with chromium-nickel burner-head
- Well clean with removanble iron casts.

ÜRÜN DETAYLARI

- Krom-nikel kaplı , yarıklı döküm brülör
- Sökülebilir dökümler ile kolay temizlik

GENERAL FEATURES

- Stainless steel body
- Quick easy cleaning
- Ergonomic design
- Adjustable legs
- Durable

GENEL ÖZELLİKLER

- Paslanmaz çelik gövde
- Kolay temizlenebilir hijyenik
- Ergonomik tasarım
- Ayarlanabilir ayaklar
- Uzun ömürlü

G7D100E-W ⚡

Dim(mm)LxDxH - Ebat (mm): 400x730x900
Power - Güç : 1 kW
Gross Weight - Ağırlık : 60 kg
Gross Volume - Hacim : 0,46 m³
Electrical Inlet - Elektrik Girişi : 230 V N PE
Price - Fiyat : 542 €



G7D100E ⚡

Dim(mm)LxDxH - Ebat (mm): 400x730x900
Power - Güç : 1 kW
Gross Weight - Ağırlık : 65 kg
Gross Volume - Hacim : 0,46 m³
Electrical Inlet - Elektrik Girişi : 230 V N PE
Price - Fiyat : 595 €



PRODUCT SPECIFICATIONS

- GN 1/1 container with oil strainer
- Ceramic infrared heater keeps fried potatoes at correct temperature
- Removable container for easy cleaning

ÜRÜN DETAYLARI

- Yağ süzgeçli GN 1/1 patates haznesi
- Seramik infrared ısıtıcı kızarmış patateslerin özel porselen infrared ısıtıcı ile sıcak kalması sağlanır
- Çıkarılabilir ve kolay temizlenebilir patates haznesi

GENERAL FEATURES

- Stainless steel body
- Quick easy cleaning
- Ergonomic design
- Adjustable legs
- Durable
- Drain valve
- Gn containers are excluded

GENEL ÖZELLİKLER

- Paslanmaz çelik gövde
- Kolay temizlenebilir hijyenik
- Ergonomik tasarım
- Ayarlanabilir ayaklar
- Uzun ömürlü
- Tahliye vanası
- Gn kaplar dahil değildir

G7S100E-W ⚡

Dim(mm)LxDxH - Ebat (mm): 400x730x900
Power - Güç : 1 kW
Gross Weight - Ağırlık : 47 kg
Gross Volume - Hacim : 0,46 m³
Electrical Inlet - Elektrik Girişi : 230 V 1N PE
Tank Capacity - Havuz Kapasitesi : GN 1/3 150 mm x 1 - GN 2/3 150 mm x 1
Price - Fiyat : 733 €



G7S100E ⚡

Dim(mm)LxDxH - Ebat (mm): 400x730x900
Power - Güç : 1 kW
Gross Weight - Ağırlık : 51 kg
Gross Volume - Hacim : 0,46 m³
Electrical Inlet - Elektrik Girişi : 230 V 1N PE
Tank Capacity - Havuz Kapasitesi : GN 1/3 150 mm x 1 - GN 2/3 150 mm x 1
Price - Fiyat : 786 €



PRODUCT SPECIFICATIONS

- 1/1 press pressure bain-marie with pool
- Well design according to GN container dimensions
- Scratch-proof enamel coated cast iron back grate
- Thermostat temperature control
- Indicator lights
- Silicon tube heaters under the tank
- GN's are excluded, subject to separate order

ÜRÜN DETAYLARI

- 1/1 pres baskı benmari havuzlu
- Gn ölçülerine uygun ısıtma havuzu
- Çizilmez ve paslanmaz emaye dökme demir baca
- Termostatik ısı kontrolü
- Uyarı ışıkları
- Havuz altında silikon rezistanslar
- Gastronomlar dahil değildir, ayrı sipariş edilir

G7S200E-W ⚡

Dim(mm)LxDxH – Ebat (mm): 800x730x900
Power - Güç : 2 kW
Gross Weight - Ağırlık : 71 kg
Gross Volume - Hacim : 0,87 m³
Electrical Inlet - Elektrik Girişi : 230 V 1N PE
Tank Capacity - Havuz Kapasitesi : GN 1/1 150 mm x1 - GN 1/3 150mmx3
Price - Fiyat : 903 €



G7S200E ⚡

Dim(mm)LxDxH – Ebat (mm): 800x730x900
Power - Güç : 2 kW
Gross Weight - Ağırlık : 79 kg
Gross Volume - Hacim : 0,87 m³
Electrical Inlet - Elektrik Girişi : 230 V 1N PE
Tank Capacity - Havuz Kapasitesi : GN 1/1 150 mm x1 - GN 1/3 150mmx3
Price - Fiyat : 1.009 €



GENERAL FEATURES

- Stainless steel body
- Quick easy cleaning
- Safety valf with ventile
- Ergonomic design
- Adjustable legs
- Durable
- Available for lpg or natural gas

GENEL ÖZELLİKLER

- Paslanmaz çelik gövde
- Kolay temizlenebilir hijyenik
- Emniyet ventili gaz valfi
- Ergonomik tasarım
- Ayarlanabilir ayaklar
- Uzun ömürlü
- Doğalgaz ve Lpg ile çalışmaya uygundur.

G7L100G

Dim(mm)LxDxH - Ebat (mm):	400x730x900
Power - Güç	: 9 kW
Gross Weight - Ağırlık	: 78 kg
Gross Volume - Hacim	: 0,46 m ³
Gas Inlet - Gaz Girişi	: R ½ "
Price - Fiyat	: 1.004 €



G7L200G

Dim(mm)LxDxH - Ebat (mm):	800x730x900
Power - Güç	: 18 kW
Gross Weight - Ağırlık	: 132 kg
Gross Volume - Hacim	: 0,87 m ³
Gas Inlet - Gaz Girişi	: R ½ "
Price - Fiyat	: 1.451 €



PRODUCT SPECIFICATIONS

- Heavy duty bottom cast iron griddle
- Consistent cooking surface
- Stainless steel V-shape grilling grate
- Waste oil drawer
- Large sized draining drawer
- Piezo spark ignition
- Two independent cooking surfaces
- Sloped cooking surface for easy maintenance with drain
- Body insulated to prevent overheating and energy loss

ÜRÜN DETAYLARI

- Demir dökümden yapılmış uzun ömürlü lavtası alt ızgarası
- Homojen pişirme yüzeyi
- Çelik " v "şeklinde pişirme ızgarası
- Atık yağ haznesi
- Büyük hacimli boşaltma çekmecesini
- Piezoelektrik ateşlemeli brülör
- Bölgesel pişirme
- Çevre saçlarının ısınması ve ısı kayıplarını minimum düzeye indiren izolasyon
- Kolay ve rahat temizlik için hafif eğimli pişirme yüzeyi

GENERAL FEATURES

- Stainless steel body
- Easy to clean and hygienic
- Ergonomic design
- Adjustable legs
- Water drawer
- Durable

G7V100G

Dim(mm)LxDxH - Ebat (mm):	400x730x900
Power - Güç	: 9 kW
Gross Weight - Ağırlık	: 103 kg
Gross Volume - Hacim	: 0,46 m ³
Gas Inlet - Gaz Girişi	: R ½ "
Price - Fiyat	: 1.227 €

G7V200G

Dim(mm)LxDxH - Ebat (mm):	800x730x900
Power - Güç	: 18 kW
Gross Weight - Ağırlık	: 176 kg
Gross Volume - Hacim	: 0,87 m ³
Gas Inlet - Gaz Girişi	: R ½ "
Price - Fiyat	: 1.991 €

PRODUCT SPECIFICATIONS

- Thanks to water reservoir under cast cooking surface, vaporization is provided during cooking process and dehydration of food being cooked is prevented.
- Special design griddles on cooking surface can be removed easily. This feature provides convenience for cleaning and maintenance.
- The water reservoir that can be interfered from front face has drawers and it can be removed easily.
- Residuary oil flows through cooking grill and it goes to the water reservoir. So inflammation of oil is prevented.
- This version has two separate firing zones.
- Isolation that minimizes heating of periphery metal sheet and heat abduction.
- Mouldings that are designed specially and that breaks fires.
- Heavy duty iron castings

GENEL ÖZELLİKLER

- Paslanmaz çelik gövde
- Kolay temizlenebilir hijyenik
- Ergonomik tasarım
- Ayarlanabilir ayaklar
- Su çekmecesi
- Uzun ömürlü



ÜRÜN DETAYLARI

- Döküm pişirme yüzeyi altındaki su haznesi sayesinde pişirme işlemi sırasında buharlaşma sağlanır ve pişirilen gıdanın dehidrasyonu önlenir.
- Pişirme yüzeyindeki özel tasarım ızgaralar kolayca çıkarılabilir. Bu özellik temizlik ve bakım için kolaylık sağlar.
- Ön taraftan müdahale edilebilen su haznesi çekmecelerine sahiptir ve kolayca çıkarılabilir.
- Atık yağ, eğimli döküm ızgaradan akarak sıvı boşaltma deliğinden atık yağ haznesinde depolanır. Böylece yağ birikimi önlenir.
- İkili brülör sistemi sayesinde tekli ve ikili yanma bölgesi.
- Çevre saçlarının ısınması ve ısı kayıplarını minimum düzeye indiren izolasyon
- Özel işlenmiş pik döküm oluklar
- Yüksek sıcaklığa dayanıklı dökümler

GENERAL FEATURES

- Stainless steel body
- Quick easy cleaning
- Ergonomic design
- Adjustable legs
- Durable

GENEL ÖZELLİKLER

- Paslanmaz çelik gövde
- Kolay temizlenebilir hijyenik
- Ergonomik tasarım
- Ayarlanabilir ayaklar
- Uzun ömürlü

G7T100N

Dim(mm)LxDxH - Ebat (mm): 400x730x900
Gross Weight - Ağırlık : 41 kg
Gross Volume - Hacim : 0,46 m³
Price - Fiyat : 415 €



G7T200N

Dim(mm)LxDxH - Ebat (mm): 800x730x900
Gross Weight - Ağırlık : 58 kg
Gross Volume - Hacim : 0,87 m³
Price - Fiyat : 516 €



PRODUCT SPECIFICATIONS

- Base cabinet with door - without door
- Scratch-proof and enameled cast iron back grate

ÜRÜN DETAYLARI

- Kapaklı, kapaksız alt dolap
- Çizilmez ve paslanmaz emaye dökme demir baca

G7T100N-W

Dim(mm)LxDxH - Ebat (mm): 400x730x900
Gross Weight - Ağırlık : 37 kg
Gross Volume - Hacim : 0,46 m³
Price - Fiyat : 362 €



G7T200N-W

Dim(mm)LxDxH - Ebat (mm): 800x730x900
Gross Weight - Ağırlık : 50 kg
Gross Volume - Hacim : 0,87 m³
Price - Fiyat : 410 €



Base Unit • Alt Dolap

Series 700

GENERAL FEATURES

- Stainless steel body
- Easy to clean and hygienic
- Ergonomic design
- Adjustable legs
- Durable

GENEL ÖZELLİKLER

- Paslanmaz Çelik Gövde
- Kolay temizlenir ve hijyeniktir
- Ergonomik dizayn
- Ayarlanabilir ayaklar
- Uzun ömürlü

G7/9100-200-201 Kapı - Door 095.100.0007

Features : Cabinet Door
Price- Fiyat : 55 €



Silver Series

Series 600

Series 700

Series 700S

Series 900



Code : 095.100.0020
Features : Reduction for 700 Series



Code : 095.100.0021
Features : Reduction For 900 Series



Code : 095.100.0018 -7/9SCL
(G7/9L 100/200G)
Features : Scraper For Lavastone



Code : 040.04.02.150
Features : Lavastone Charcoal



Code : 020.03.10.056
Features : Extra enameled coated GN 2/1 x 65mm tray for all ranges



Code : 095.100.0019 -7/9SCI
(G7/9I 110-220-210)
Features : Scraper For Griddle



Code : 020.02.04.251
Features : Extra grid for all ranges
2 / 1 Grid -Size: 535x590 mm

KUSINA®

COOKING SERIES - PİŞİRİCİ SERİSİ

Series 700S • 700S Seri





GENERAL FEATURES

- Kusina 700S serie offers you medium size cooking equipments with the performance of bigger products.
- In 700S serie you can find full range of free standing and counter top models with flexibility and functionality.
- 700S serie is a smart professional solution for cafes, restaurants and hotels up to 300 meals per day.
- 700S serie designed with high thicknesses, round shapes, easy cleaning removable trays and unscratchable washable grids.
- 700S serie is a high powered modular line with robustness, safety and ergonomics that fullfills all needs of professional chefs.
- The 700S serie produce with custom alloy resistances, 316 SS tanks, hard-chromium cover, high quality components for long life.

GENEL ÖZELLİKLER

- Kusina 700S serisi, büyük serilerin sunduğu performansı , orta ölçekte sunar.
- 700S serisinde aranan tüm modeller esnek ve fonksiyonel olarak bulunur.
- Günde 300 yemek servisini aşmayan restoran otel ve kafeteryalar için 700 serisi çok akıllıca bir çözümdür.
- 700S serisi yıkanabilir yağdanlıkları , çizilmez dökümleri yuvarlatılmış hatları ve kalın saç kullanımı ile tasarlanıp üretilmiştir.
- 700S serisi SS316'dan üretilmiş Havuzları , özel alaşımli ısıtıcıları , sert krom kaplaması ve yüksek kaliteli parçaları ile uzun ömürlü bir üründür.

GENERAL FEATURES

- Stainless steel body
- Quick easy cleaning
- Gas valf with safety relief
- Ergonomic design
- Adjustable legs
- Durable
- High efficiency burner

GENEL ÖZELLİKLER

- Paslanmaz çelik gövde
- Kolay temizlenebilir hijyenik
- Emniyet ventili gaz valfi
- Ergonomik tasarım
- Ayarlanabilir ayaklar
- Uzun ömürlü
- Yüksek verimli brülör

G7K101G-S

Dim(mm)LxDxH - Ebat (mm):	400x730x300
Burner kW- Brülör kW	: 6,5 kW x 1
Power - Güç	: 6,5 kW
Gross Weight - Ağırlık	: 25,5 kg
Gross Volume - Hacim	: 0,18 m ³
Gas Inlet - Gaz Girişi	: R ½ "
Price - Fiyat	: 745 €



G7K100G-S

Dim(mm)LxDxH - Ebat (mm):	400x730x300
Burner kW- Brülör kW	: 6,5 kW x 2
Power - Güç	: 0,18 m ³
Gross Weight - Ağırlık	: 32,5 kg
Gross Volume - Hacim	: 0,24 m ³
Gas Inlet - Gaz Girişi	: R ½ "
Price - Fiyat	: 818 €



PRODUCT SPECIFICATIONS

- Available with 1,2,4 and 6 burners
- Removable bottom burner tray for easy cleaning and maintenance
- Scratch-proof enamel coated cast iron top plates and back grate
- Nickel coated cast iron burners
- Protected pilot flame
- Self stabilizing flame

ÜRÜN DETAYLARI

- 1,2,4 ve 6 açık ateşli
- Kolay temizlik ve bakım-onarım sağlayan çıkarılabilir brülör alt tepsi
- Emaye kaplı dökme demir çizilmez kolay temizlenebilir baca ve üst ızgara
- Dökme demir nikel kaplamalı ocakları
- Korumalı pilot alevi
- Stabilize ocak pilot alevleri

G7K200G-S 

Dim(mm)LxDxH - Ebat (mm): 800x730x300
Burner kW- Brülör kW : 6,5 kW x 4
Power - Güç : 26 kW
Gross Weight - Ağırlık : 70,5 kg
Gross Volume - Hacim : 0,41 m³
Gas Inlet - Gaz Girişi : R ½ "
Price - Fiyat : 1.257 €



G7K201G-S 

Dim(mm)LxDxH - Ebat (mm): 1200x730x300
Burner kW- Brülör kW : 6,5 kW x 6
Power - Güç : 39 kW
Gross Weight - Ağırlık : 108 kg
Gross Volume - Hacim : 0,61 m³
Gas Inlet - Gaz Girişi : R ½ "
Price - Fiyat : 1.601 €



GENERAL FEATURES

- Stainless steel body
- Quick easy cleaning
- Ergonomic design
- Adjustable legs
- Durable

GENEL ÖZELLİKLER

- Paslanmaz çelik gövde
- Kolay temizlenebilir hijyenik
- Ergonomik tasarım
- Ayarlanabilir ayaklar
- Uzun ömürlü

G7K100E-S ⚡

Dim(mm)LxDxH - Ebat (mm):	400x730x300
Plates - Isıtıcı Pleyt	: 2,0 kW x 1 - 2,6 kW x 1
Power - Güç	: 4,6 kW
Gross Weight - Ağırlık	: 22 kg
Gross Volume - Hacim	: 0,24 m ³
Electrical Inlet - Elektrik Girişi	: 400V 3N PE
Price - Fiyat	: 491 €



G7K200E-S ⚡

Dim(mm)LxDxH - Ebat (mm):	800x730x300
Plates- Isıtıcı Pleyt	: 2,0 kW x 2 - 2,6 kW x 2
Power - Güç	: 9,2 kW
Gross Weight - Ağırlık	: 54,5 kg
Gross Volume - Hacim	: 0,41 m ³
Electrical Inlet - Elektrik Girişi	: 400 V 3N PE
Price - Fiyat	: 767 €



PRODUCT SPECIFICATIONS

- Thermal hot plates
- 2 or 4 heating plates
- Ø 180 mm and Ø 230 mm -two types of cooking plates
- Unscratchable enameled cast iron back grate scratch
- Adjustable thermostat temperature control

ÜRÜN DETAYLARI

- Termikli hot pleytler
- 2,4 ve ısıtıcı pleytli
- Ø 180 ve Ø 230 mm olmak üzere iki çeşit pişirme pleyti
- Çizilmez ve paslanmaz emaye dökme demir baca
- Ayarlanabilir termostatlı sıcaklık kontrolü

G7K100E-S-K ⚡

Dim(mm)LxDxH - Ebat (mm): 400x730x300
Plates - Isıtıcı Pleyt : 2,6 kW x 2
Power - Güç : 5,2 kW
Gross Weight - Ağırlık : 30 kg
Gross Volume - Hacim : 0,18 m³
Electrical Inlet - Elektrik Girişi : 400V 3N PE
Price - Fiyat : 726 €



G7K200E-S-K ⚡

Dim(mm)LxDxH - Ebat (mm): 800x730x300
Plates - Isıtıcı Pleyt : 2,6 kW x 4
Power - Güç : 10,4 kW
Gross Weight - Ağırlık : 54 kg
Gross Volume - Hacim : 0,41 m³
Electrical Inlet - Elektrik Girişi : 400V 3N PE
Price - Fiyat : 1.212 €



G7K201E-S-K ⚡

Dim(mm)LxDxH - Ebat (mm): 1200x730x300
Plates - Isıtıcı Pleyt : 2,6 kW x 6
Power - Güç : 15,6 kW
Gross Weight - Ağırlık : 81 kg
Gross Volume - Hacim : 0,61 m³
Electrical Inlet - Elektrik Girişi : 400V 3N PE
Price - Fiyat : 2.223 €



GENERAL FEATURES

- KUSINA induction products are committed to delivering more power, efficiency, stable and consistent performance in the kitchen and beyond.
- KUSINA takes induction technology to the next level with high controllability and reaction time that's as sleek as it is robust.
- For kitchens, these new induction ranges not only cooking like gas / electric, they exceed them.
- Impressive technology for power, reliability, and control like nothing you have ever laid your hands on.

GENEL ÖZELLİKLER

- KUSINA indüksiyon ocakları daha fazla güç, verimli ve tutarlı performans sunmayı, mutfakta ve ötesinde taahhüt etmektedir.
- KUSINA, sağlam olduğu kadar şık, yüksek kontrol edilebilirlik ve reaksiyon süresi ile indüksiyon teknolojisini bir üst seviye ye taşır.
- Yeni indüksiyon ocakları gazlı elektrikli ocaklar gibi sadece pişirmekle kalmaz, onların üstünde bir performans gösterir.
- Güç için etkileyici teknoloji, güvenilirlik ve daha önce deneyimlemediğiniz bir kontrol edilebilirlik.

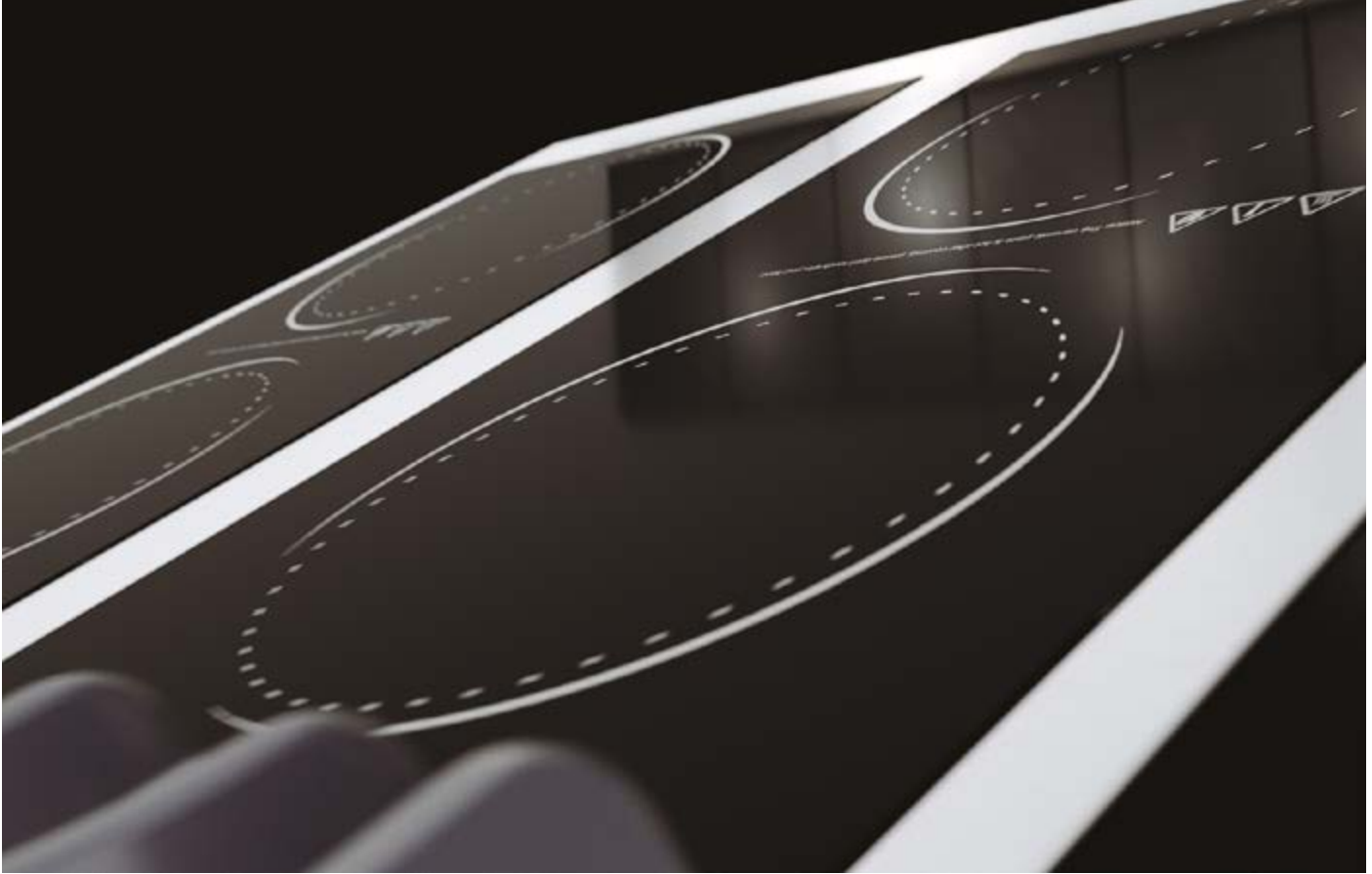

PRODUCT SPECIFICATIONS

- Very durable ceramic induction hobs
- Automatic overheating protection system
- Seamless interaction with pan
- Stable / consistent performance
- Maximum controllability
- Reaction time less then 1 second
- High temperature cooking
- Effective isolation

ÜRÜN DETAYLARI

- Dayanıklı indüksiyon camları
- Yüksek sıcaklık koruma sistemi
- Tava ile kesintisiz temas (etkileşim)
- Kararlı/ tutarlı performans
- Üst düzey kontrol edilebilirlik
- 1 saniyenin altında tepki süresi
- Yüksek sıcaklıkta pişirme
- Etkin yalıtım

GENERAL FEATURES

- Stainless steel body
- Quick easy cleaning
- Ergonomic design
- Adjustable legs
- Durable

GENEL ÖZELLİKLER

- Paslanmaz çelik gövde
- Kolay temizlenebilir hijyenik
- Ergonomik tasarım
- Ayarlanabilir ayaklar
- Uzun ömürlü

G7IN100E-S ⚡

Dim(mm)LxDxH – Ebat (mm): 400x730x300
Power – Güç : 7 kW
Gross Weight – Ağırlık : 34 kg
Gross Volume – Hacim : 0,18 m³
Electrical Inlet – Elektrik Girişi : 400V 3N PE
Price – Fiyat : 4.162 €



G7IN200E-S ⚡

Dim(mm)LxDxH – Ebat (mm): 800x730x300
Power – Güç : 14 kW
Gross Weight – Ağırlık : 52 kg
Gross Volume – Hacim : 0,41 m³
Electrical Inlet – Elektrik Girişi : 400 V 3N PE
Price – Fiyat : 8.037 €



G7WIN100E-S ⚡

Induction Wok Cooker / İndüksiyon Wok Pişirici

Dim(mm)LxDxH – Ebat (mm): 400x730x300
Power – Güç : 5 kW
Gross Weight – Ağırlık : 29 kg
Gross Volume – Hacim : 0,18 m³
Electrical Inlet – Elektrik Girişi : 230 V 1N PE
Price – Fiyat : 4.125 €



GENERAL FEATURES

- Stainless steel body
- Quick easy cleaning
- Ergonomic design
- Adjustable legs
- Durable
- Single or double cooking containers

GENEL ÖZELLİKLER

- Paslanmaz çelik gövde
- Kolay temizlenebilir hijyenik
- Ergonomik tasarım
- Ayarlanabilir ayaklar
- Uzun ömürlü
- Tekli ve Çiftli Havuz

G7M100E-S ⚡

Dim(mm)LxDxH - Ebat (mm)	: 400x730x300
Power - Güç	: 6 kW
Gross Weight - Ağırlık	: 24 kg
Gross Volume - Hacim	: 0,18 m ³
Electrical Inlet - Elektrik Girişi	: 400 V 3N PE
Basket Size - Sepet Boyu	: 145x270x150 (1 pcs) - 135x180x150 (2 pcs)
Capacity - Kapasite	: 14 lt
Price - Fiyat	: 1.129 €



G7M200E-S ⚡

Dim(mm)LxDxH - Ebat (mm)	: 800x730x300
Power - Güç	: 12 kW
Gross Weight - Ağırlık	: 60 kg
Gross Volume - Hacim	: 0,41 m ³
Electrical Inlet - Elektrik Girişi	: 400 V 3N PE
Basket Size - Sepet Boyu	: 145x270x150 (2 pcs) - 135x180x150 (4 pcs)
Capacity - Kapasite	: 2x14 lt
Price - Fiyat	: 1.759 €



PRODUCT SPECIFICATIONS

- Safe thermostat temperature control
- Indicator light when reaching required temperature
- Custom alloy heaters
- Operating temperature range (0-100 ° C)
- Baskets not included
- Manual water filling
- Heaters with incoloy material

ÜRÜN DETAYLARI

- Güvenli termostat sıcaklık kontrolü
- Sıcaklığa ulaştığında açma-kapama ışıkları
- Özel Alaşım ısıtıcılar
- Çalışma ısı aralığı (0-100 ° C)
- Sepetler dahil değildir
- Manuel su doldurma
- Incoloy malzemeli ısıtıcılar

GENERAL FEATURES

- Stainless steel body
- Quick easy cleaning
- Safety gas valve
- Ergonomic design
- Adjustable legs
- Durable
- High efficiency burner
- Available lpg or natural gas

GENEL ÖZELLİKLER

- Paslanmaz çelik gövde
- Kolay temizlenebilir hijyenik
- Emniyet ventili gaz valfi
- Ergonomik tasarım
- Ayarlanabilir ayaklar
- Uzun ömürlü
- Yüksek verimli brülör
- Doğal gaz ve LPG ile çalışabilir



PRODUCT SPECIFICATIONS

- Top plates available in smooth, ribbed or combination plates
- 15mm thick griddle plate in ST 52 steel, or hard chromium coated steel
- 3 mm thickness cover sheet
- Sloped cooking surface for easy maintenance with drain
- Consistent heating cooking surface
- Machined grooved plates
- Large sized draining drawer
- Thermostat temperature control (electrical)
- Thermocouple safety device connected to the burner
- Piezo spark ignition double independent cooking surface
- Insulated to prevent overheating and energy loss
- Round corners to eas proper cleaning

ÜRÜN DETAYLARI

- Pişirme yüzeyinin düz, oluklu veya oluklu+düz versiyonları
- 15 mm kalınlığında st 52 çelik veya sert krom kaplı çelik platina ızgaralar
- Pişirme yüzeyinin çevresi 3mm kalınlığında paslanmaz çelik
- Kolay ve rahat temizlik için hafif eğimli pişirme yüzeyi
- Homojen ısınan pişirme yüzeyi
- Özel işlenmiş oluklar
- Büyük hacimli boşaltma çekmeces
- Termostatik sıcaklık kontrolü (Elektrikli Ürünlerde)
- Brülöre bağlı termokupl emniyet sistemi
- Piezoelektrik ateşlemeli brülör bir veya iki bağımsız pişirme bölgesi versiyonları
- Çevre saçlarının ısınması ve ısı kayıplarını minimum düzeye indiren izolasyon
- Yuvarlatılmış köşe tasarımı ile kolay temizlik

G7I100E-S ⚡

Dim(mm)LxDxH - Ebat (mm) : 400x730x300
 Power - Güç : 3,6 kW
 Gross Weight - Ağırlık : 49,5 kg
 Gross Volume - Hacim : 0,18 m³
 Smooth - Düz : 1/1
 Electrical Inlet - Elektrik Girişi : 400 V 3N PE
 Price - Fiyat : 791 €

**G7I110E-S** ⚡

Dim(mm)LxDxH - Ebat (mm) : 400x730x300
 Power - Güç : 3,6 kW
 Gross Weight - Ağırlık : 54,5 kg
 Gross Volume - Hacim : 0,18 m³
 Ribed - Oluklu : 1/1
 Electrical Inlet - Elektrik Girişi : 400 V 3N PE
 Price - Fiyat : 1.050 €

**G7I200E-S** ⚡

Dim(mm)LxDxH - Ebat (mm) : 800x730x300
 Power - Güç : 7,2 kW
 Gross Weight - Ağırlık : 94 kg
 Gross Volume - Hacim : 0,41 m³
 Smooth - Düz : 1/1
 Electrical Inlet - Elektrik Girişi : 400 V 3N PE
 Price - Fiyat : 1.118 €



G7I 210E-S ⚡

Dim(mm)LxDxH - Ebat (mm): 800x730x300
 Power - Güç : 7,2 kW
 Gross Weight - Ağırlık : 103 kg
 Gross Volume - Hacim : 0,41 m³
 Ribed - Oluklu : 1/1
 Electrical Inlet - Elektrik Girişi : 400 V 3N PE
 Price - Fiyat : 1.366 €

**G7I 220E-S** ⚡

Dim(mm)LxDxH - Ebat (mm): 800x730x300
 Power - Güç : 7,2 kW
 Gross Weight - Ağırlık : 103 kg
 Gross Volume - Hacim : 0,41 m³
 Smooth - Düz : 1/2
 Ribed - Oluklu : 1/2
 Electrical Inlet - Elektrik Girişi : 400 V 3N PE
 Price - Fiyat : 1.268 €

**G7I 100G-S** 🔥

Dim(mm)LxDxH - Ebat (mm): 400x730x300
 Power - Güç : 6,5 kW
 Gross Weight - Ağırlık : 53 kg
 Gross Volume - Hacim : 0,18 m³
 Gas Inlet - Gaz Girişi : R 1/2 "
 Smooth - Düz : 1/1
 Price - Fiyat : 737 €



G7I 110G-S 

Dim(mm)LxDxH - Ebat (mm):	400x730x300
Power - Güç	: 6,5 kW
Gross Weight - Ağırlık	: 58 kg
Gross Volume - Hacim	: 0,18 m ³
Gas Inlet - Gaz Girişi	: R ½ "
Ribed - Oluklu	: 1/1
Price - Fiyat	: 878 €

**G7I 200G-S** 

Dim(mm)LxDxH - Ebat (mm):	800x730x300
Power - Güç	: 13 kW
Gross Weight - Ağırlık	: 94 kg
Gross Volume - Hacim	: 0,41 m ³
Gas Inlet - Gaz Girişi	: R ½ "
Smooth - Düz	: 1/1
Price - Fiyat	: 1.105 €

**G7I 210G-S** 

Dim(mm)LxDxH - Ebat (mm):	800x730x300
Power - Güç	: 13 kW
Gross Weight - Ağırlık	: 103 kg
Gross Volume - Hacim	: 0,41 m ³
Gas Inlet - Gaz Girişi	: R ½ "
Ribed - Oluklu	: 1/1
Price - Fiyat	: 1.391 €



G7I 220G-S 

Dim(mm)LxDxH - Ebat (mm): 800x730x300
 Power - Güç : 13 kW
 Gross Weight - Ağırlık : 103 kg
 Gross Volume - Hacim : 0,41 m³
 Gas Inlet - Gaz Girişi : R ½ "
 Smooth - Düz : 1/2
 Ribed - Oluklu : 1/2
 Price - Fiyat : 1.295 €



G7I100E-SC 

Dim(mm)LxDxH - Ebat (mm): 400x730x300
 Power - Güç : 3,6 kW
 Gross Weight - Ağırlık : 49,5 kg
 Gross Volume - Hacim : 0,21 m³
 Smooth - Düz : 1/1
 Electrical Inlet - Elektrik Girişi : 400 V 3N PE
 Chrome Plated - Krom Plate : 1/1
 Price - Fiyat : 1.060 €



G7I110E-SC 

Dim(mm)LxDxH - Ebat (mm): 400x730x300
 Power - Güç : 3,6 kW
 Gross Weight - Ağırlık : 54,5 kg
 Gross Volume - Hacim : 0,18 m³
 Ribed - Oluklu : 1/1
 Electrical Inlet - Elektrik Girişi : 400 V 3N PE
 Chrome Plated - Krom Plate : 1/1
 Price - Fiyat : 1.319 €



G7I 200E-SC ⚡

Dim(mm)LxDxH - Ebat (mm): 800x730x300
 Power - Güç : 7,2 kW
 Gross Weight - Ağırlık : 94 kg
 Gross Volume - Hacim : 0,41 m³
 Smooth - Düz : 1/1
 Electrical Inlet - Elektrik Girişi : 400 V 3N PE
 Chrome Plated - Krom Plate : 1/1
 Price - Fiyat : 1.597 €

**G7I 210E-SC** ⚡

Dim(mm)LxDxH - Ebat (mm): 800x730x300
 Power - Güç : 7,2 kW
 Gross Weight - Ağırlık : 103 kg
 Gross Volume - Hacim : 0,41 m³
 Ribed - Oluklu : 1/1
 Electrical Inlet - Elektrik Girişi : 400 V 3N PE
 Chrome Plated - Krom Plate : 1/1
 Price - Fiyat : 1.845 €

**G7I 220E-SC** ⚡

Dim(mm)LxDxH - Ebat (mm): 800x730x300
 Power - Güç : 7,2 kW
 Gross Weight - Ağırlık : 103 kg
 Gross Volume - Hacim : 0,41 m³
 Smooth - Düz : 1/2
 Ribed - Oluklu : 1/2
 Electrical Inlet - Elektrik Girişi : 400 V 3N PE
 Chrome Plated - Krom Plate : 1/1
 Price - Fiyat : 1.747 €

**G7I 100G-SC** 🔥

Dim(mm)LxDxH - Ebat (mm): 400x730x300
 Power - Güç : 6,5 kW
 Gross Weight - Ağırlık : 53 kg
 Gross Volume - Hacim : 0,18 m³
 Gas Inlet - Gaz Girişi : R 1/2 "
 Smooth - Düz : 1/1
 Chrome Plated - Krom Plate : 1/1
 Price - Fiyat : 1.005 €

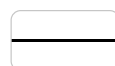

G7I 10G-SC 

Dim(mm)LxDxH - Ebat (mm) : 400x730x300
 Power - Güç : 6,5 kW
 Gross Weight - Ağırlık : 58 kg
 Gross Volume - Hacim : 0,18 m³
 Gas Inlet - Gaz Girişi : R ½ "
 Ribed - Oluklu : 1/1
 Chrome Plated - Krom Plate : 1/1
 Price - Fiyat : 1.147 €



G7I 200G-SC 

Dim(mm)LxDxH - Ebat (mm) : 800x730x300
 Power - Güç : 13 kW
 Gross Weight - Ağırlık : 94 kg
 Gross Volume - Hacim : 0,41 m³
 Gas Inlet - Gaz Girişi : R ½ "
 Smooth - Düz : 1/1
 Chrome Plated - Krom Plate : 1/1
 Price - Fiyat : 1.583 €



G7I 210G-SC 

Dim(mm)LxDxH - Ebat (mm) : 800x730x300
 Power - Güç : 13 kW
 Gross Weight - Ağırlık : 103 kg
 Gross Volume - Hacim : 0,41 m³
 Gas Inlet - Gaz Girişi : R ½ "
 Ribed - Oluklu : 1/1
 Chrome Plated - Krom Plate : 1/1
 Price - Fiyat : 1.870 €



G7I 220G-SC 

Dim(mm)LxDxH - Ebat (mm) : 800x730x300
 Power - Güç : 13 kW
 Gross Weight - Ağırlık : 103 kg
 Gross Volume - Hacim : 0,41 m³
 Gas Inlet - Gaz Girişi : R ½ "
 Smooth - Düz : 1/2
 Ribed - Oluklu : 1/2
 Chrome Plated - Krom Plate : 1/1
 Price - Fiyat : 1.774 €

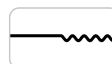

GENERAL FEATURES

- Stainless steel body
- Quick easy cleaning
- Ergonomic design
- Adjustable legs
- Durable

GENEL ÖZELLİKLER

- Paslanmaz çelik gövde
- Kolay temizlenebilir hijyenik
- Ergonomik tasarım
- Ayarlanabilir ayaklar
- Uzun ömürlü

G7F100E-S ⚡

Dim(mm)LxDxH - Ebat (mm):	400x730x300
Power - Güç	: 7,5 kW
Gross Weight - Ağırlık	: 27 kg
Gross Volume - Hacim	: 0,18 m ³
Electrical Inlet - Elektrik Girişi	: 400 V 3N PE
Basket Size - Sepet Ölçüsü	: 200x260x115 (1 pcs)
Capacity - Kapasite	: 10 lt
Price - Fiyat	: 976 €



G7F200E-S ⚡

Dim(mm)LxDxH - Ebat (mm):	800x730x300
Power - Güç	: 7,5 kW x 2
Gross Weight - Ağırlık	: 60 kg
Gross Volume - Hacim	: 0,41 m ³
Electrical Inlet - Elektrik Girişi	: 400 V 3N PE
Basket Size - Sepet Ölçüsü	: 200x260x115 (2 pcs)
Capacity - Kapasite	: 2 x 10 lt
Price - Fiyat	: 1.732 €



PRODUCT SPECIFICATIONS

- Safety thermostat
- Single or double container models
- Thermostat temperature control
- Stainless steel baskets
- Adjustable temperature
- Operation and heating control indicator lights

ÜRÜN DETAYLARI

- Emniyet termostatlı
- Tekli veya çift havuzlu modelleri
- Termostatlı sıcaklık kontrolü
- Paslanmaz sepetler
- Ayarlanabilir ısı derecesi
- Çalıştırma ve sıcaklık sinyal lambaları

GENERAL FEATURES

- Stainless steel body
- Quick easy cleaning
- Ergonomic design
- Adjustable legs
- Durable
- Gn containers are excluded

GENEL ÖZELLİKLER

- Paslanmaz çelik gövde
- Kolay temizlenebilir hijyenik
- Ergonomik tasarım
- Ayarlanabilir ayaklar
- Uzun ömürlü
- Gn kaplar dahil değildir.

G7S100E-S ⚡

Dim(mm)LxDxH - Ebat (mm): 400x730x300
Power - Güç : 1 kW
Gross Weight - Ağırlık : 23 kg
Gross Volume - Hacim : 0,18 m³
Electrical Inlet - Elektrik Girişi : 230 V 1N PE
Tank Capacity - Havuz Kapasitesi: GN 1/1 150 mm x 1 - GN 1/3 150 mm x 3
Price - Fiyat : 592 €



G7S200E-S ⚡

Dim(mm)LxDxH - Ebat (mm): 800x730x300
Power - Güç : 2 kW
Gross Weight - Ağırlık : 45 kg
Gross Volume - Hacim : 0,41 m³
Electrical Inlet - Elektrik Girişi : 230 V 1N PE
Tank Capacity - Havuz Kapasitesi: GN1/1x150mm 1 - GN1/3 150 mm x 2
Price - Fiyat : 930 €



PRODUCT SPECIFICATIONS

- Press printing bain-marie with pool
- Well design according to GN containers dimension
- Scratch-proof enamel coated cast iron back grate
- Thermostat temperature control
- Silicon tube heaters under the tank
- Indicator lights

ÜRÜN DETAYLARI

- Pres baskı benmari havuzlu
- Gn ölçülerine uygun ısıtma havuzu
- Çizilmez ve paslanmaz emaye dökme demir baca
- Termostatik ısı kontrolü
- Havuz altında silikon tüp rezistansları
- Gösterge ışıkları

GENERAL FEATURES

- Stainless steel body
- Quick easy cleaning
- Safety valf with ventile
- Ergonomic design
- Adjustable legs
- Durable
- Available for lpg or natural gas

GENEL ÖZELLİKLER

- Paslanmaz çelik gövde
- Kolay temizlenebilir hijyenik
- Emniyet ventili gaz valfi
- Ergonomik tasarım
- Ayarlanabilir ayaklar
- Uzun ömürlü
- Doğalgaz ve Lpg ile çalışmaya uygundur.

G7L100G-S 🔥

Dim(mm)LxDxH - Ebat (mm):	400x730x300
Power - Güç:	9 kW
Gross Weight - Ağırlık:	63 kg
Gross Volume - Hacim:	0,18 m ³
Gas Inlet - Gaz Girişi:	R ½ "
Price - Fiyat:	693 €



G7L200G-S 🔥

Dim(mm)LxDxH - Ebat (mm):	800x730x300
Power - Güç:	18 kW
Gross Weight - Ağırlık:	106 kg
Gross Volume - Hacim:	0,41 m ³
Gas Inlet - Gaz Girişi:	R ½ "
Price - Fiyat:	1.145 €



PRODUCT SPECIFICATIONS

- Heavy duty bottom iron cast
- Consistent cooking surface
- Stainless steel V-shape grilling grate
- Waste oil drawer
- Large sized draining drawer
- Two independent cooking surfaces
- Body insulated to prevent overheating and energy loss
- Sloped cooking surface for easy maintenance and cleaning with drain

ÜRÜN DETAYLARI

- Demir dökümden yapılmış uzun ömürlü lavtaşı alt ızgarası
- Homojen pişirme yüzeyi
- Çelik "v" şeklinde hareketli pişirme ızgarası'
- Büyük hacimli boşaltma çekmecesı
- Piezoelektrik ateşlemeli brülör
- İki bağımsız pişirme bölgesi
- Çevre saçlarının ısınması ve ısı kayıplarını minimum düzeye indiren izolasyon
- Kolay ve rahat temizlik için hafif eğimli pişirme yüzeyi, sıvı boşaltma delikli

GENERAL FEATURES

- Stainless steel body
- Easy to clean and hygienic
- Ergonomic design
- Adjustable legs
- Water drawer
- Durable

GENEL ÖZELLİKLER

- Paslanmaz çelik gövde
- Kolay temizlenebilir hijyenik
- Ergonomik tasarım
- Ayarlanabilir ayaklar
- Su çekmecesi
- Uzun ömürlü

G7V100G-S

NEW

Dim(mm)LxDxH - Ebat (mm)	: 400x730x300
Power - Güç	: 9 kW
Gross Weight - Ağırlık	: 70 kg
Gross Volume - Hacim	: 0.21 m ³
Gas Inlet - Gaz Girişi	: R ½ "
Price - Fiyat	: 1.030 €



G7V200G-S

NEW

Dim(mm)LxDxH - Ebat (mm)	: 800x730x300
Power - Güç	: 18 kW
Gross Weight - Ağırlık	: 130 kg
Gross Volume - Hacim	: 0.45 m ³
Gas Inlet - Gaz Girişi	: R ½ "
Price - Fiyat	: 1.686 €



PRODUCT SPECIFICATIONS

- Thanks to water reservoir under cast cooking surface, vaporization is provided during cooking process and dehydration of food being cooked is prevented.
- Special design griddles on cooking surface can be removed easily. This feature provides convenience for cleaning and maintenance.
- The water reservoir that can be interfered from front face has drawers and it can be removed easily.
- Residuary oil flows through cooking grill and it goes to the water reservoir. So inflammation of oil is prevented.
- This version has two separate firing zones.
- Isolation that minimizes heating of periphery metal sheet and heat abduction.
- Mouldings that are designed specially and that breaks fires.
- Heavy duty iron castings

ÜRÜN DETAYLARI

- Döküm pişirme yüzeyi altındaki su haznesi sayesinde pişirme işlemi sırasında buharlaşma sağlanır ve pişirilen gıdanın dehidrasyonu önlenir.
- Pişirme yüzeyindeki özel tasarım ızgaralar kolayca çıkarılabilir. Bu özellik temizlik ve bakım için kolaylık sağlar.
- Ön taraftan müdahale edilebilen su haznesi çekmecelerine sahiptir ve kolayca çıkarılabilir.
- Atık yağ, eğimli döküm ızgaradan akarak sıvı boşaltma deliğinden atık yağ haznesinde depolanır. Böylece yağ birikimi önlenir.
- İkili brülör sistemi sayesinde tekli ve ikili yanma bölgesi.
- Çevre saçlarının ısınması ve ısı kayıplarını minimum düzeye indiren izolasyon
- Özel işlenmiş pik döküm oluklar
- Yüksek sıcaklığa dayanıklı dökümler

GENERAL FEATURES

- Stainless steel body
- Easy to clean and hygienic
- Ergonomic design
- Adjustable legs
- Durable
- Heavy duty iron castings

GENEL ÖZELLİKLER

- Paslanmaz çelik gövde
- Kolay temizlenebilir hijyenik
- Ergonomik tasarım
- Ayarlanabilir ayaklar
- Uzun ömürlü
- Sanayi tipi ağır dökümler

G7W100G-S

Dim(mm)LxDxH - Ebat (mm):	400x730x300
Power - Güç	: 15 kW
Gross Weight - Ağırlık	: 28 kg
Gross Volume - Hacim	: 0,18 m ³
Gas Inlet - Gaz Girişi	: R ½ "
Price - Fiyat	: 717 €



PRODUCT SPECIFICATIONS

- Iron cast burners, with chromium-nickel burner-head
- Well clean with removanble iron casts.

ÜRÜN DETAYLARI

- Krom-nikel kaplı , yarıklı döküm brülör
- Sökülebilir dökümler ile kolay temizlik

Chip Scuttle • Patates Dinlendirme

GENERAL FEATURES

- Stainless steel body
- Quick easy cleaning
- Ergonomic design
- Adjustable legs
- Durable

GENEL ÖZELLİKLER

- Paslanmaz çelik gövde
- Kolay temizlenebilir hijyenik
- Ergonomik tasarım
- Ayarlanabilir ayaklar
- Uzun ömürlü

G7D100E-S ⚡

Dim(mm)LxDxH - Ebat (mm):	400x730x300
Power - Güç	: 1 kW
Gross Weight - Ağırlık	: 22,5 kg
Gross Volume - Hacim	: 0,18 m ³
Electrical Inlet - Elektrik Girişi	: 230 V 1N PE
Price - Fiyat	: 472 €



PRODUCT SPECIFICATIONS

- Well design according to GN1/1
- Ceramic infrared heater keeps fried potatoes at correct temperature

ÜRÜN DETAYLARI

- GN1/1 ölçülerine uygun tasarım
- Kızarmış patateslerin özel seramik infrared ısıtıcı ile sıcak kalması sağlanır

GENERAL FEATURES

- Stainless steel body
- Quick easy cleaning
- Ergonomic design
- Adjustable legs
- Durable

GENEL ÖZELLİKLER

- Paslanmaz çelik gövde
- Kolay temizlenebilir hijyenik
- Ergonomik tasarım
- Ayarlanabilir ayaklar
- Uzun ömürlü

G7T100N-S

Dim(mm)LxDxH - Ebat (mm): 400x730x300
Gross Weight - Ağırlık : 16 kg
Gross Volume - Hacim : 0,18 m³
Price - Fiyat : 246 €



G7T200N-S

Dim(mm)LxDxH - Ebat (mm): 800x730x300
Gross Weight - Ağırlık : 30 kg
Gross Volume - Hacim : 0,41 m³
Price - Fiyat : 295 €



PRODUCT SPECIFICATIONS

- Scratch-proof enamelled, cleanable iron cast chimney

ÜRÜN DETAYLARI

- Çizilmez ve paslanmaz emaye dökme demir baca

GENERAL FEATURES

- Stainless steel body
- Easy to clean and hygienic
- Ergonomic design
- Adjustable legs
- Long life

GENEL ÖZELLİKLER

- Paslanmaz Çelik Gövde
- Kolay temizlenir ve hijyeniktir
- Ergonomik dizayn
- Ayarlanabilir ayaklar
- Uzun ömürlü

G7ST100-W

Features	: Open Base Unit
Dim(mm)LxDxH - Ebat (mm)	: 400x700x600
Gross Weight - Ağırlık	: 16 kg
Gross Volume - Hacim	: 0,22 m ³
Price- Fiyat	: 246 €



G7ST200-W

Features	: Open Base Unit
Dim(mm)LxDxH - Ebat (mm)	: 800x700x600
Gross Weight - Ağırlık	: 22 kg
Gross Volume - Hacim	: 0,40 m ³
Price- Fiyat	: 270 €



G7ST201-W

Features	: Open Base Unit
Dim(mm)LxDxH - Ebat (mm)	: 1200x700x600
Gross Weight - Ağırlık	: 28 kg
Gross Volume - Hacim	: 0,60 m ³
Price- Fiyat	: 294 €



G7ST 100/200/201 095.100.0034

Features	: Cabinet Door
Price- Fiyat	: 55 €





Code : 095.100.0020
Features : Reduction for 700 Series



Code : 095.100.0021
Features : Reduction For 900 Series



Code : 095.100.0018 - 7/9SCL
(G7/9L 100/200G)
Features : Scrapper For Lavastone



Code : 040.04.02.150
Features : Lavastone Charcoal



Code : 020.03.10.056
Features : Extra enameled coated GN 2/1x65 mm tray for all ranges



Code : 095.100.0019 -7/9SCI
(G7/9I 110-220-210)
Features : Scrapper For Griddle



Code : 020.02.04.251
 : 020.02.04.250
Features : Extra grid for all ranges
 2 / 1 Grid -Size: 535x590 mm



Code : 020.03.10.052
Features : Extra S/S GN 2/1x65 mm tray for all series

KUSINA®

COOKING SERIES - PİŞİRİCİ SERİSİ

Series 900 • 900 Seri





GENERAL FEATURES

- Kusina 900 series is high performing efficient cooking line with powerful burners and lots of benefits. Completely removable burner hubs, removable oil trays with rounded edges and unscrutable grids guarantee for easy quick cleaning and hygiene.
- Kusina 900 series is well-designed modular line and can be combined with 700 series.
- The 900 series produce with custom alloy resistances, 316 SS tank, hard-chromium cover, high quality components for long life.

GENEL ÖZELLİKLER

- 900 serisi güçlü brülörleri ve pek çok diğer avantajı ile yüksek performanslı verimli pişirme hatlarıdır.
- Komple çıkarılabilir brülörleri, yıkanabilir yağdanlıkları , çizilmez dökümleri ve yuvarlatılmış hatları ile kolay temizlik ve hijyen sağlar.
- Kusina 900 serisi modüler sistemler sunar ve 700 serisi ile eşleşebilir.
- SS316'dan üretilmiş havuzları, özel alaşımli ısıtıcıları ,sert krom kaplaması ve yüksek kaliteli parçaları ile uzun ömürlü bir üründür.

GENERAL FEATURES

- Stainless steel body
- Quick easy cleaning
- Safety gas valve
- Ergonomic design
- Adjustable legs
- Durable
- High efficiency burner
- Insulated oven

GENEL ÖZELLİKLER

- Paslanmaz çelik gövde
- Kolay temizlenebilir hijyenik
- Emniyet ventili gaz valfi
- Ergonomik tasarım
- Ayarlanabilir ayaklar
- Uzun ömürlü
- Yüksek verimli brülör
- İzolasyonlu fırın



PRODUCT SPECIFICATIONS

- 2/4 and 6/8 burners , with or without oven
- Easy to clean and simple maintenance with removable burner bottom tray
- Unscratchable and enameled cast iron top grates.
- Nickel coated cast iron burners
- Protected pilot flame
- With oven or cupboards
- Oven available for 2/1 GN trays
- Enamel coated bottom steel sheet the body of the oven is made of aluminium coated sheet metal
- Stainless steel double-wall, insulated door
- Self stabilizing flame
- Removable and easy to clean stainless steel oven shelves
- Thermostatic temperature control with safety valve and thermocouple
- Piezo-electric burner ignition

ÜRÜN DETAYLARI

- 2,4 ve 6 açık ateşli, fırınlı ve fırınsız modeller
- Kolay temizlik ve bakım-onarım sağlayan çıkarılabilir brülör alt tepsisi
- Emaye kaplı dökme demir çizilmez kolay temizlenebilir baca ve üst ızgara
- Dökme demir nikel kaplamalı ocakları
- Korumalı pilot alevi
- Fırınlı veya alt dolaplı
- Fırın içi GN 2/1 ölçülerine uygun
- Alüminyum kaplı sacdan yapılmış fırın gövdesi
- Paslanmaz çelikten yapılmış çift cidarlı izolasyonlu kapak
- Stabilize ocak pilot alevleri
- Çıkarılabilir ve kolay temizlenebilir paslanmaz çelik fırın rafları
- Sıcaklık ayarlı termostatik emniyet valfli fırın gaz vanası
- Piezoelektrik ateşleme fırın pilotu

G9K100G-W 

Dim(mm)LxDxH - Ebat (mm): 400x900x900
Burners kW - Brülör kW : 8,5 kW x 2
Power - Güç : 17 kW
Gross Weight - Ağırlık : 63,5 kg
Gross Volume - Hacim : 0,53 m³
Gas Inlet - Gaz Girişi : R ½ "
Price - Fiyat : 1.000 €



G9K100G 

Dim(mm)LxDxH - Ebat (mm): 400x900x900
Burners kW - Brülör kW : 8,5 kW x 2
Power - Güç : 17 kW
Gross Weight - Ağırlık : 67,5 kg
Gross Volume - Hacim : 0,53 m³
Gas Inlet - Gaz Girişi : R ½ "
Price - Fiyat : 1.053 €



G9K200G-W 

Dim(mm)LxDxH - Ebat (mm): 800x900x900
 Burners kW - Brülör kW : 8,5 kW x 4
 Power - Güç : 34 kW
 Gross Weight - Ağırlık : 105 kg
 Gross Volume - Hacim : 1,05 m³
 Gas Inlet - Gaz Girişi : R ½"
 Price - Fiyat : 1.519 €



G9K200G 

Dim(mm)LxDxH - Ebat (mm): 800x900x900
 Burners kW - Brülör kW : 8,5 kW x 4
 Power - Güç : 34 kW
 Gross Weight - Ağırlık : 113 kg
 Gross Volume - Hacim : 1,05 m³
 Gas Inlet - Gaz Girişi : R ½"
 Price - Fiyat : 1.625 €



G9K201G-W 🔥

Dim(mm)LxDxH - Ebat (mm): 1200x900x900
Burners kW - Brülör kW : 8,5 kW x 6
Power - Güç : 52 kW
Gross Weight - Ağırlık : 155 kg
Gross Volume - Hacim : 1,52 m³
Gas Inlet - Gaz Girişi : R ½"
Price - Fiyat : 2.081 €



G9K201G 🔥

Dim(mm)LxDxH - Ebat (mm): 1200x900x900
Burners kW - Brülör kW : 8,5 kW x 6
Power - Güç : 52 kW
Gross Weight - Ağırlık : 167 kg
Gross Volume - Hacim : 1,52 m³
Gas Inlet - Gaz Girişi : R ½"
Price - Fiyat : 2.240 €



G9K203G-W 

Dim(mm)LxDxH - Ebat (mm): 1600x900x900
Burners kW - Brülör kW : 8.5 kW x 8
Power - Güç : 68 kW
Gross Weight - Ağırlık : 169 kg
Gross Volume - Hacim : 1,85 m³
Gas Inlet - Gaz Girişi : R1/2" (2 pcs)
Price - Fiyat : 3.360 €

**G9K203G** 

Dim(mm)LxDxH - Ebat (mm): 1600x900x900
Burners kW - Brülör kW : 8.5 kW x 8
Power - Güç : 68 kW
Gross Weight - Ağırlık : 185 kg
Gross Volume - Hacim : 1,85 m³
Gas Inlet - Gaz Girişi : R1/2" (2 pcs)
Price - Fiyat : 3.568 €



G9K210G 

.....●

Dim(mm)LxDxH - Ebat (mm):	800x900x900
Burners kW - Brülör kW	: 8,5 kW x 4
Power - Güç	: 40 kW
Gross Weight - Ağırlık	: 157,5 kg
Gross Volume - Hacim	: 1,05 m ³
Gas Inlet - Gaz Girişi	: R ½ "
Tray Dimensions - Tepsi boyutları	: GN 2/1x2
Oven kW - Fırın kW	: 6 kW
Price - Fiyat	: 2.179 €



G9K211G-W 

Dim(mm)LxDxH - Ebat (mm):	1200x900x900
Burners kW - Brülör kW	: 8,5 kW x 6
Power - Güç	: 58 kW
Gross Weight - Ağırlık	: 211 kg
Gross Volume - Hacim	: 1,52 m ³
Gas Inlet - Gaz Girişi	: R ½ "
Tray Dimensions - Tepsi boyutları:	GN 2/1x2
Oven kW - Fırın kW	: 6 kW
Price - Fiyat	: 2.694 €

**G9K211G** 

Dim(mm)LxDxH - Ebat (mm):	1200x900x900
Burners kW - Brülör kW	: 8,5 kW x 6
Power - Güç	: 58 kW
Gross Weight - Ağırlık	: 215 kg
Gross Volume - Hacim	: 1,52 m ³
Gas Inlet - Gaz Girişi	: R ½ "
Tray Dimensions - Tepsi boyutları:	GN 2/1x2
Oven kW - Fırın kW	: 6 kW
Price - Fiyat	: 2.800 €



G9K212G 🔥

Dim(mm)LxDxH - Ebat (mm):	1200x900x900
Burners kW - Brülör kW	: 8,5 kW x 6
Power - Güç	: 63 kW
Gross Weight - Ağırlık	: 237 kg
Gross Volume - Hacim	: 1,52 m ³
Gas Inlet - Gaz Girişi	: R ½ "
Oven kW - Fırın kW	: 10 kW
Tray Dimensions - Tepsi boyutları	: 900x590x65mm - 2 pcs
Price - Fiyat	: 3.433 €

**G9K213G** 🔥

Dim(mm)LxDxH - Ebat (mm):	1600x900x900
Burners kW - Brülör kW	: 8.5 kW x 8
Power - Güç	: 82 kW
Gross Weight - Ağırlık	: 275 kg
Gross Volume - Hacim	: 1,85 m ³
Gas Inlet - Gaz Girişi	: R1/2" (2 pcs)
Oven kW - Fırın kW	: 6 kWx2
Tray Dimensions - Tepsi boyutları	: GN 2/1 x 4
Price - Fiyat	: 4.568 €



G9K220G 

Dim(mm)LxDxH - Ebat (mm):	800x900x900
Power - Güç	: 5 kW
Gross Weight - Ağırlık	: 110 kg
Gross Volume - Hacim	: 1,05 m ³
Gas Inlet - Gaz Girişi	: R ½ "
Price - Fiyat	: 1.080 €

**G9K221G** 

Dim(mm)LxDxH - Ebat (mm):	800x900x900
Solid Plate	: 5 kW
Power - Güç	: 11 kW
Gross Weight - Ağırlık	: 135 kg
Gross Volume - Hacim	: 1,05 m ³
Gas Inlet - Gaz Girişi	: R ½ "
Tray dimension - Tepsi boyutları:	GN2/1x2
Oven kW - Fırın kW	: 6 kW
Price - Fiyat	: 1.996 €



GENERAL FEATURES

- Stainless steel body
- Quick easy cleaning
- Ergonomic design
- Adjustable legs
- Durable
- Insulated oven

GENEL ÖZELLİKLER

- Paslanmaz çelik gövde
- Kolay temizlenebilir hijyenik
- Ergonomik tasarım
- Ayarlanabilir ayaklar
- Uzun ömürlü
- İzolasyonlu fırın



PRODUCT SPECIFICATIONS

- 2, 4 or 6 heating plates, with or without oven models
- Unscratchable enameled cast iron back grate scratch proff enamel coated cast iron back grate
- With oven or cupboards oven or storage cabinet
- Position rack guides for 2/1 GN racks
- Oven constructed of aluminium coated sheet metal
- Stainless steel double-wall, insulated door
- Adjustable temperature level control

ÜRÜN DETAYLARI

- 2,4 ve 6 ısıtıcı pleytli, fırınlı ve fırınlı modeller
- Çizilmez ve paslanmaz emaye dökme demir baca
- Fırınlı veya alt dolaplı
- Fırın içi GN 2/1 ölçülerine uygun
- Alüminyum kaplı sacdan yapılmış fırın gövdesi
- Paslanmaz çelikten yapılmış çift cidarlı izolasyonlu kapı
- Kademeli sıcaklık kontrolü

G9K100E-W ⚡

Dim(mm)LxDxH - Ebat (mm): 400x900x900
Plates-Isıttıcı Pleyt : 3 kW x 2
Power - Güç : 6 kW
Gross Weight - Ağırlık : 72,5 kg
Gross Volume - Hacim : 0,53 m³
Electrical Inlet - Elektrik Girişi : 400 V 3N PE
Price - Fiyat : 1.084 €

**G9K100E** ⚡

Dim(mm)LxDxH - Ebat (mm): 400x900x900
Plates-Isıttıcı Pleyt : 3 kW x 2
Power - Güç : 6 kW
Gross Weight - Ağırlık : 76,5 kg
Gross Volume - Hacim : 0,53 m³
Electrical Inlet - Elektrik Girişi : 400 V 3N PE
Price - Fiyat : 1.137 €



G9K200E-W ⚡

Dim(mm)LxDxH - Ebat (mm): 800x900x900
Plates-Isıttıcı Pleyt : 3 kW x 4
Power - Güç : 12 kW
Gross Weight - Ağırlık : 121 kg
Gross Volume - Hacim : 1,05 m³
Electrical Inlet - Elektrik Girişi : 400 V 3N PE
Price - Fiyat : 1.669 €



G9K200E ⚡

Dim(mm)LxDxH - Ebat (mm): 800x900x900
Plates-Isıttıcı Pleyt : 3 kW x 4
Power - Güç : 12 kW
Gross Weight - Ağırlık : 129 kg
Gross Volume - Hacim : 1,05 m³
Electrical Inlet - Elektrik Girişi : 400 V 3N PE
Price - Fiyat : 1.775 €



G9K201E-W ⚡

Dim(mm)LxDxH – Ebat (mm): 1200x900x900
 Plates-Isıtıcı Pleyt : 3 kW X 6
 Power - Güç : 18 kW
 Gross Weight - Ağırlık : 182 kg
 Gross Volume - Hacim : 1,52 m³
 Electrical Inlet - Elektrik Girişi : 400 V 3N PE
 Price - Fiyat : 3.000 €

**G9K201E** ⚡**NEW**

Dim(mm)LxDxH – Ebat (mm): 1200x900x900
 Plates-Isıtıcı Pleyt : 3 kW X 6
 Power - Güç : 18 kW
 Gross Weight - Ağırlık : 194 kg
 Gross Volume - Hacim : 1,52 m³
 Electrical Inlet - Elektrik Girişi : 400 V 3N PE
 Price - Fiyat : 3.171 €

**G9K210E** ⚡

Dim(mm)LxDxH – Ebat (mm): 800x900x900
 Plates-Isıtıcı Pleyt : 3 kW x 4
 Power - Güç : 18 kW
 Gross Weight - Ağırlık : 170 kg
 Gross Volume - Hacim : 1,05 m³
 Electrical Inlet - Elektrik Girişi : 400 V 3N PE
 Tray Dimensions – Tepsi boyutları : GN 2/1x2
 Oven kW - Fırın kW : 6 kW
 Price - Fiyat : 2.492 €



G9K211E-W ⚡**NEW**

Dim(mm)LxDxH – Ebat (mm): 1200x900x900
 Plates-Isıtıcı Pleyt : 3 kW X 6
 Power – Güç : 24 kW
 Gross Weight – Ağırlık : 243 kg
 Gross Volume – Hacim : 1,52 m³
 Electrical Inlet – Elektrik Girişi : 400 V 3N PE
 Oven kW – Fırın kW : 6 kW
 Tray Dimensions – Tepsi boyutları : GN 2/1 x 2
 Price – Fiyat : 3.135 €

**G9K211E** ⚡**NEW**

Dim(mm)LxDxH – Ebat (mm): 1200x900x900
 Plates-Isıtıcı Pleyt : 3 kW X 6
 Power – Güç : 24 kW
 Gross Weight – Ağırlık : 247 kg
 Gross Volume – Hacim : 1,52 m³
 Electrical Inlet – Elektrik Girişi : 400 V 3N PE
 Oven kW – Fırın kW : 6 kW
 Tray Dimensions – Tepsi boyutları : 900x590x65mm – 2 pcs
 Price – Fiyat : 3.186 €

**G9K212E** ⚡**NEW**

Dim(mm)LxDxH – Ebat (mm): 1200x900x900
 Plates-Isıtıcı Pleyt : 3 kW X 6
 Power – Güç : 27 kW
 Gross Weight – Ağırlık : 256 kg
 Gross Volume – Hacim : 1,52 m³
 Electrical Inlet – Elektrik Girişi : 400 V 3N PE
 Oven kW – Fırın kW : 9 kW
 Tray Dimensions – Tepsi boyutları : 900x590x65 – 2 pcs
 Price – Fiyat : 3.345 €



GENERAL FEATURES

- KUSINA induction products are committed to delivering more power, efficiency, stable and consistent performance in the kitchen and beyond.
- KUSINA takes induction technology to the next level with high controllability and reaction time that's as sleek as it is robust.
- For kitchens, these new induction ranges not only cooking like gas / electric, they exceed them.
- Impressive technology for power, reliability, and control like nothing you have ever laid your hands on.

GENEL ÖZELLİKLER

- KUSINA indüksiyon ocakları daha fazla güç, verimli ve tutarlı performans sunmayı, mutfakta ve ötesinde taahhüt etmektedir.
- KUSINA, sağlam olduğu kadar şık, yüksek kontrol edilebilirlik ve reaksiyon süresi ile indüksiyon teknolojisini bir üst seviye ye taşır.
- Yeni indüksiyon ocakları gazlı elektrikli ocaklar gibi sadece pişirmekle kalmaz, onların üstünde bir performans gösterir.
- Güç için etkileyici teknoloji, güvenilirlik ve daha önce deneyimlemediğiniz bir kontrol edilebilirlik.

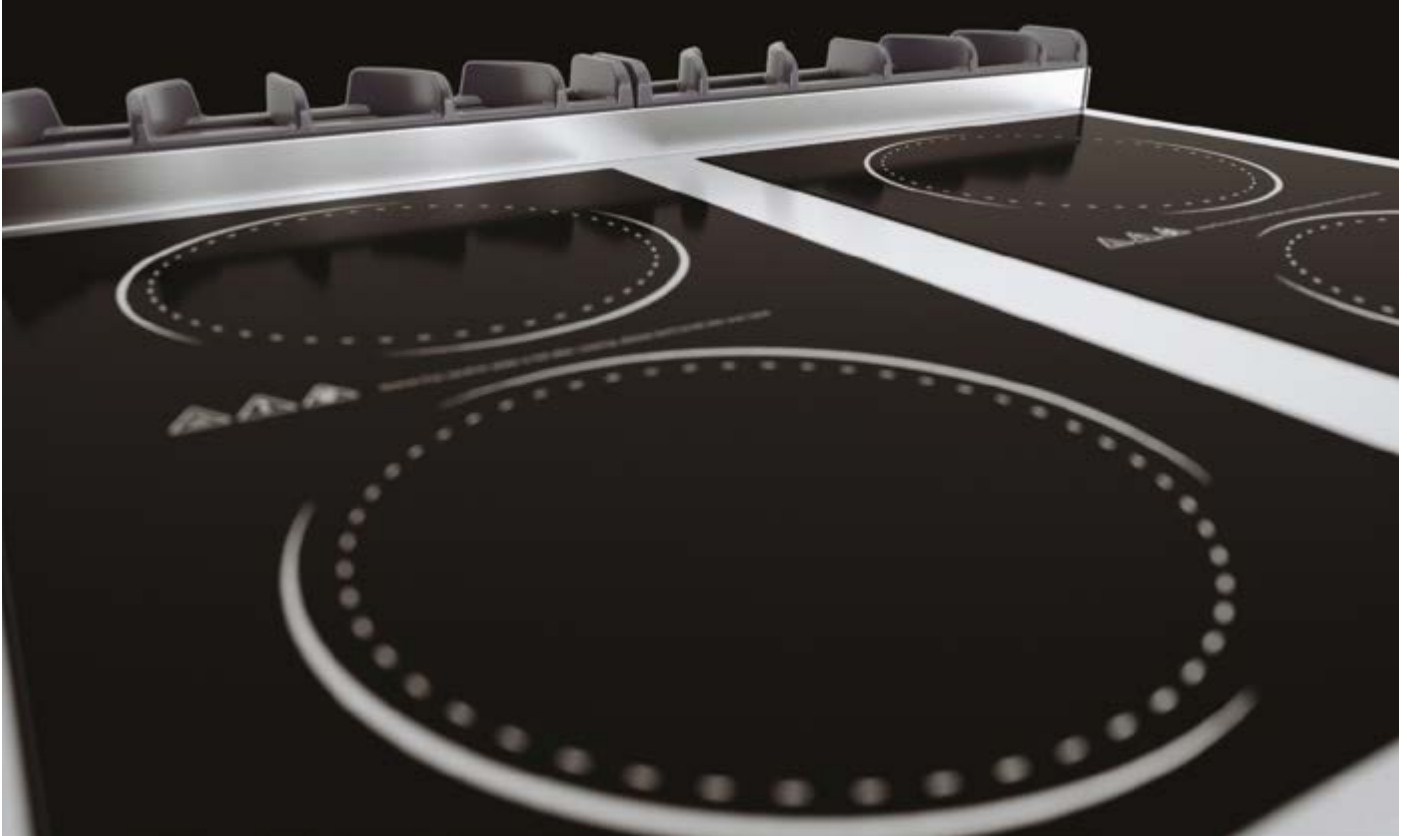

PRODUCT SPECIFICATIONS

- Very durable ceramic induction hobs
- Automatic overheating protection system
- Seamless interaction with pan
- Stable / consistent performance
- Maximum controllability
- Reaction time less then 1 second
- High temperature cooking
- Effective isolation

ÜRÜN DETAYLARI

- Dayanıklı indüksiyon camları
- Yüksek sıcaklık koruma sistemi
- Tava ile kesintisiz temas (etkileşim)
- Kararlı/ tutarlı performans
- Üst düzey kontrol edilebilirlik
- 1 saniyenin altında tepki süresi
- Yüksek sıcaklıkta pişirme
- Etkin yalıtım

GENERAL FEATURES

- Stainless steel body
- Quick easy cleaning
- Ergonomic design
- Adjustable legs
- Durable

GENEL ÖZELLİKLER

- Paslanmaz çelik gövde
- Kolay temizlenebilir hijyenik
- Ergonomik tasarım
- Ayarlanabilir ayaklar
- Uzun ömürlü

G9IN100E-W ⚡

Dim(mm)LxDxH - Ebat (mm): 400x900x900
Power - Güç : 10 kW
Gross Weight - Ağırlık : 64 kg
Gross Volume - Hacim : 0,53 m³
Electrical Inlet - Elektrik Girişi : 400 V 3N PE
Price - Fiyat : 4.760 €



G9IN200E-W ⚡

Dim(mm)LxDxH - Ebat (mm): 800x900x900
Power - Güç : 20 kW
Gross Weight - Ağırlık : 112 kg
Gross Volume - Hacim : 1,05 m³
Electrical Inlet - Elektrik Girişi : 400 V 3N PE
Price - Fiyat : 9.125 €



G9WIN100E-W ⚡

Dim(mm)LxDxH - Ebat (mm): 400x900x900
Power - Güç : 5 kW
Gross Weight - Ağırlık : 56 kg
Gross Volume - Hacim : 0,53 m³
Electrical Inlet - Elektrik Girişi : 230 V 1N PE
Price - Fiyat : 4.725 €



GENERAL FEATURES

- Stainless steel body
- Quick easy cleaning
- Ergonomic design
- Adjustable legs
- Durable

GENEL ÖZELLİKLER

- Paslanmaz çelik gövde
- Kolay temizlenebilir hijyenik
- Ergonomik tasarım
- Ayarlanabilir ayaklar
- Uzun ömürlü

G9IN100E ⚡

Dim(mm)LxDxH - Ebat (mm): 400x900x900
Power - Güç : 10 kW
Gross Weight - Ağırlık : 68 kg
Gross Volume - Hacim : 0,53 m³
Electrical Inlet - Elektrik Girişi : 400 V 3N PE
Price - Fiyat : 4.815 €



G9IN200E ⚡

Dim(mm)LxDxH - Ebat (mm): 800x900x900
Power - Güç : 20 kW
Gross Weight - Ağırlık : 120 kg
Gross Volume - Hacim : 1,05 m³
Electrical Inlet - Elektrik Girişi : 400 V 3N PE
Price - Fiyat : 9.235 €



G9WIN100E ⚡

Dim(mm)LxDxH - Ebat (mm): 400x900x900
Power - Güç : 5 kW
Gross Weight - Ağırlık : 58 kg
Gross Volume - Hacim : 0,53 m³
Electrical Inlet - Elektrik Girişi : 230 V 1N PE
Price - Fiyat : 4.780 €



Pasta Cooker • Makarna Haşlama

Series 900

GENERAL FEATURES

- Stainless steel body
- Quick easy cleaning
- Ergonomic design
- Adjustable legs
- Durable
- Single or double cooking containers

GENEL ÖZELLİKLER

- Paslanmaz çelik gövde
- Kolay temizlenebilir hijyenik
- Ergonomik tasarım
- Ayarlanabilir ayaklar
- Uzun ömürlü
- Tekli ve Çiftli Havuz

G9M100E ⚡

Dim(mm)LxDxH - Ebat (mm): 400x900x900

Power - Güç : 9 kW

Gross Weight - Ağırlık : 64,5 kg

Gross Volume - Hacim : 0,53 m³

Electrical Inlet - Elektrik Girişi : 400 V 3N PE

Capacity - Kapasite : 24 lt

Basket Size - Sepet Ölçüsü : 220x150x210 (1 pcs) 110x150x210 (4 pcs)

Price - Fiyat : 1.293 €

G9M100G 🔥

Dim(mm)LxDxH - Ebat (mm): 400x900x900

Power - Güç : 12 kW

Gross Weight - Ağırlık : 88,5 kg

Gross Volume - Hacim : 0,53 m³

Gas Inlet - Gaz Girişi : R ½ "

Capacity - Kapasite : 24 lt

Basket Size - Sepet Ölçüsü : 220x150x240 (1 pcs) 110x150x240 (4 pcs)

Price - Fiyat : 1.418 €

G9M200E ⚡

Dim(mm)LxDxH - Ebat (mm): 800x900x900

Power - Güç : 18 kW

Gross Weight - Ağırlık : 97 kg

Gross Volume - Hacim : 1,05 m³

Electrical Inlet - Elektrik Girişi : 400 V 3N PE

Capacity - Kapasite : 2x24 lt

Basket Size - Sepet Ölçüsü : 220x150x210 (2 pcs) 110x150x210 (8pcs)

Price - Fiyat : 2.045 €

PRODUCT SPECIFICATIONS

- Thermostatic control
- Well desinged avoid to overflow
- Stainless steel tube heater
- Operating temperature range (0-100 ° C)
- 316 SS quality tank
- 304 SS quality baskets
- Special alloy resistances
- Indicator light when reaching required temperature
- Heaters with incoloy material
- Water filling battery
- Magneto ignition system (gas)
- Safety gas valve (gas)
- Stainless burner (gas)
- Baskets not included

ÜRÜN DETAYLARI

- Termostatik kontrol
- Taşmayı önleyici tasarım
- Paslanmaz çelik boru ısıtıcı
- Çalışma ısısı aralığı (0-100 ° C)
- 316 SS kalite havuz
- 304 SS kalite sepetler
- Özel alaşım rezistanslar
- Sıcaklığa ulaştığında açma-kapama ışıkları
- Incoloy malzemeli ısıtıcılar
- Su doldurma bataryası
- Manyetolu ateşleme sistemi (gazlı)
- Emniyetli gaz valfi (gazlı)
- Paslanmaz brülör (gazlı)
- Sepetler dahil değildir



GENERAL FEATURES

- Stainless steel body
- Quick easy cleaning
- Safety gas valve
- Ergonomic design
- Adjustable legs
- Durable
- High efficiency burner
- Available lpg or natural gas

GENEL ÖZELLİKLER

- Paslanmaz çelik gövde
- Kolay temizlenebilir hijyenik
- Emniyet ventili gaz valfi
- Ergonomik tasarım
- Ayarlanabilir ayaklar
- Uzun ömürlü
- Yüksek verimli brülör
- Doğal gaz ve LPG ile çalışabilir



PRODUCT SPECIFICATIONS

- Top plates available in smooth, ribbed or combination plates
- Fry top with storage cabinet
- 15mm thick griddle plate in ST 52 steel, or hard chromium coated steel
- 3 mm thickness cover plate
- Stainless steel oil collection drawer is placed in cupboard in cabinet
- Sloped cooking surface for easy maintenance with drain
- Consistent heating cooking surface
- Machined grooved plates
- Large sized draining drawer
- Thermostat temperature control (For electrical device)
- Thermocouple safety device connected to the burner
- Piezo spark ignition double independent cooking surface
- Insulated to prevent overheating and energy loss
- Round corners to easy proper cleaning

ÜRÜN DETAYLARI

- Pişirme yüzeyinin düz, oluklu veya oluklu+düz versiyonları
- Izgara altı kapaklı dolap
- 15 mm kalınlığında st 52 çelik veya sert krom kaplı çelik platına ızgaralar
- Pişirme yüzeyinin çevresi 3mm kalınlığında paslanmaz çelik
- Dolap içerisine yerleştirilmiş paslanmaz çelik yağ toplama çekmecesini
- Kolay ve rahat temizlik için hafif eğimli pişirme yüzeyi
- Homojen ısınan pişirme yüzeyi
- Özel işlenmiş oluklar
- Büyük hacimli boşaltma çekmecesini
- Termostatik sıcaklık kontrolü (Elektrikli ürünler için)
- Brülöre bağlı termokupl emniyet sistemi
- Piezoelektrik ateşlemeli brülör bir veya iki bağımsız pişirme bölgesi versiyonları
- Çevre saçlarının ısınması ve ısı kayıplarını minimum düzeye indiren izolasyon
- Yuvarlatılmış köşe tasarımı ile kolay temizlik

G9I100E-W ⚡

Dim(mm)LxDxH - Ebat (mm): 400x900x900
 Power - Güç : 6 kW
 Gross Weight - Ağırlık : 79,5 kg
 Gross Volume - Hacim : 0,53 m³
 Smooth - Düz : 1/1
 Electrical Inlet - Elektrik Girişi : 400 V 3N PE
 Price - Fiyat : 1.033 €

**G9I100E** ⚡

Dim(mm)LxDxH - Ebat (mm): 400x900x900
 Power - Güç : 6 kW
 Gross Weight - Ağırlık : 83,5 kg
 Gross Volume - Hacim : 0,53 m³
 Smooth - Düz : 1/1
 Electrical Inlet - Elektrik Girişi : 400 V 3N PE
 Price - Fiyat : 1.086 €

**G9I110E-W** ⚡

Dim(mm)LxDxH - Ebat (mm): 400x900x900
 Power - Güç : 6 kW
 Gross Weight - Ağırlık : 85,5 kg
 Gross Volume - Hacim : 0,53 m³
 Ribed - Oluklu : 1/1
 Electrical Inlet - Elektrik Girişi : 400 V 3N PE
 Price - Fiyat : 1.275 €



G9I110E 

Dim(mm)LxDxH - Ebat (mm): 400x900x900
 Power - Güç : 6 kW
 Gross Weight - Ağırlık : 89,5 kg
 Gross Volume - Hacim : 0,53 m³
 Ribed - Oluklu : 1/1
 Electrical Inlet - Elektrik Girişi : 400 V 3N PE
 Price - Fiyat : 1.328 €

**G9I200E-W** 

Dim(mm)LxDxH - Ebat (mm): 800x900x900
 Power - Güç : 12 kW
 Gross Weight - Ağırlık : 143 kg
 Gross Volume - Hacim : 1,05 m³
 Smooth - Düz : 1/1
 Electrical Inlet - Elektrik Girişi : 400 V 3N PE
 Price - Fiyat : 1.506 €

**G9I200E** 

Dim(mm)LxDxH - Ebat (mm): 800x900x900
 Power - Güç : 12 kW
 Gross Weight - Ağırlık : 151 kg
 Gross Volume - Hacim : 1,05 m³
 Smooth - Düz : 1/1
 Electrical Inlet - Elektrik Girişi : 400 V 3N PE
 Price - Fiyat : 1.612 €



G9I210E-W ⚡

Dim(mm)LxDxH - Ebat (mm): 800x900x900
 Power - Güç : 12 kW
 Gross Weight - Ağırlık : 156 kg
 Gross Volume - Hacim : 1,05 m³
 Ribed - Oluklu : 1/1
 Electrical Inlet - Elektrik Girişi : 400 V 3N PE
 Price - Fiyat : 1.756 €

**G9I210E** ⚡

Dim(mm)LxDxH - Ebat (mm): 800x900x900
 Power - Güç : 12 kW
 Gross Weight - Ağırlık : 164 kg
 Gross Volume - Hacim : 1,05 m³
 Ribed - Oluklu : 1/1
 Electrical Inlet - Elektrik Girişi : 400 V 3N PE
 Price - Fiyat : 1.862 €

**G9I220E-W** ⚡

Dim(mm)LxDxH - Ebat (mm): 800x900x900
 Power - Güç : 12 kW
 Gross Weight - Ağırlık : 156 kg
 Gross Volume - Hacim : 1,05 m³
 Smooth - Düz : 1/2
 Ribed - Oluklu : 1/2
 Electrical Inlet - Elektrik Girişi : 400 V 3N PE
 Price - Fiyat : 1.680 €



G9I220E ⚡

Dim(mm)LxDxH - Ebat (mm): 800x900x900
 Power - Güç : 12 kW
 Gross Weight - Ağırlık : 164 kg
 Gross Volume - Hacim : 1,05 m³
 Smooth - Düz : 1/2
 Ribed - Oluklu : 1/2
 Electrical Inlet - Elektrik Girişi : 400 V 3N PE
 Price - Fiyat : 1.786 €

**G9I100G-W** 🔥

Dim(mm)LxDxH - Ebat (mm): 400x900x900
 Power - Güç : 9 kW
 Gross Weight - Ağırlık : 78 kg
 Gross Volume - Hacim : 0,53 m³
 Gas Inlet - Gaz Girişi : R ½ "
 Smooth - Düz : 1/1
 Price - Fiyat : 1.000 €

**G9I100G** 🔥

Dim(mm)LxDxH - Ebat (mm): 400x900x900
 Power - Güç : 9 kW
 Gross Weight - Ağırlık : 82 kg
 Gross Volume - Hacim : 0,53 m³
 Gas Inlet - Gaz Girişi : R ½ "
 Smooth - Düz : 1/1
 Price - Fiyat : 1.053 €



G9I110G-W 

Dim(mm)LxDxH - Ebat (mm): 400x900x900

Power - Güç : 9 kW

Gross Weight - Ağırlık : 82 kg

Gross Volume - Hacim : 0,53 m³

Gas Inlet - Gaz Girişi : R ½ "

Ribed - Oluklu : 1/1

Price - Fiyat : 1.212 €

**G9I110G** 

Dim(mm)LxDxH - Ebat (mm): 400x900x900

Power - Güç : 9 kW

Gross Weight - Ağırlık : 86 kg

Gross Volume - Hacim : 0,53 m³

Gas Inlet - Gaz Girişi : R ½ "

Ribed - Oluklu : 1/1

Price - Fiyat : 1.265 €

**G9I200G-W** 

Dim(mm)LxDxH - Ebat (mm): 800x900x900

Power - Güç : 18 kW

Gross Weight - Ağırlık : 127 kg

Gross Volume - Hacim : 1,05 m³

Gas Inlet - Gaz Girişi : R ½ "

Smooth - Düz : 1/1

Price - Fiyat : 1.399 €

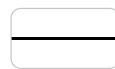

G9I200G 

Dim(mm)LxDxH - Ebat (mm):	800x900x900
Power - Güç	: 18 kW
Gross Weight - Ağırlık	: 135 kg
Gross Volume - Hacim	: 1,05 m ³
Gas Inlet - Gaz Girişi	: R ½ "
Smooth - Düz	: 1/1
Price - Fiyat	: 1.505 €

**G9I210G-W** 

Dim(mm)LxDxH - Ebat (mm):	800x900x900
Power - Güç	: 18 kW
Gross Weight - Ağırlık	: 142 kg
Gross Volume - Hacim	: 1,05 m ³
Gas Inlet - Gaz Girişi	: R ½ "
Ribed - Oluklu	: 1/1
Price - Fiyat	: 1.688 €

**G9I210G** 

Dim(mm)LxDxH - Ebat (mm):	800x900x900
Power - Güç	: 18 kW
Gross Weight - Ağırlık	: 150 kg
Gross Volume - Hacim	: 1,05 m ³
Gas Inlet - Gaz Girişi	: R ½ "
Ribed - Oluklu	: 1/1
Price - Fiyat	: 1.794 €



G9I220G-W 

Dim(mm)LxDxH - Ebat (mm): 800x900x900
 Power - Güç : 18 kW
 Gross Weight - Ağırlık : 142 kg
 Gross Volume - Hacim : 1,05 m³
 Gas Inlet - Gaz Girişi : R ½ "
 Smooth - Düz : 1/2
 Ribed - Oluklu : 1/2
 Price - Fiyat : 1.541 €



G9I220G 

Dim(mm)LxDxH - Ebat (mm): 800x900x900
 Power - Güç : 18 kW
 Gross Weight - Ağırlık : 150 kg
 Gross Volume - Hacim : 1,05 m³
 Gas Inlet - Gaz Girişi : R ½ "
 Smooth - Düz : 1/2
 Ribed - Oluklu : 1/2
 Price - Fiyat : 1.647 €



G9I100E-C-W 

Dim(mm)LxDxH - Ebat (mm): 400x900x900
 Power - Güç : 6 kW
 Gross Weight - Ağırlık : 79,5 kg
 Gross Volume - Hacim : 0,53 m³
 Smooth - Düz : 1/1
 Electrical Inlet - Elektrik Girişi : 400 V 3N PE
 Chrome Plated - Krom Plate : 1/1
 Price - Fiyat : 1.388 €

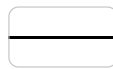

G9I100E-C ⚡

Dim(mm)LxDxH - Ebat (mm): 400x900x900
 Power - Güç : 6 kW
 Gross Weight - Ağırlık : 83,5 kg
 Gross Volume - Hacim : 0,53 m³
 Smooth - Düz : 1/1
 Electrical Inlet - Elektrik Girişi : 400 V 3N PE
 Chrome Plated - Krom Plate : 1/1
 Price - Fiyat : 1.441 €

**G9I110E-C-W** ⚡

Dim(mm)LxDxH - Ebat (mm): 400x900x900
 Power - Güç : 6 kW
 Gross Weight - Ağırlık : 85,5 kg
 Gross Volume - Hacim : 0,53 m³
 Electrical Inlet - Elektrik Girişi : 400 V 3N PE
 Ribed - Oluklu : 1/1
 Chrome Plated - Krom Plate : 1/1
 Price - Fiyat : 1.631 €

**G9I110E-C** ⚡

Dim(mm)LxDxH - Ebat (mm): 400x900x900
 Power - Güç : 6 kW
 Gross Weight - Ağırlık : 89,5 kg
 Gross Volume - Hacim : 0,53 m³
 Electrical Inlet - Elektrik Girişi : 400 V 3N PE
 Ribed - Oluklu : 1/1
 Chrome Plated - Krom Plate : 1/1
 Price - Fiyat : 1.684 €



G9I200E-C-W ⚡

Dim(mm)LxDxH - Ebat (mm): 800x900x900
 Power - Güç : 12 kW
 Gross Weight - Ağırlık : 143 kg
 Gross Volume - Hacim : 1,05 m³
 Electrical Inlet - Elektrik Girişi : 400 V 3N PE
 Smooth - Düz : 1/1
 Chrome Plated - Krom Plate : 1/1
 Price - Fiyat : 2.038 €

**G9I200E-C** ⚡

Dim(mm)LxDxH - Ebat (mm): 800x900x900
 Power - Güç : 12 kW
 Gross Weight - Ağırlık : 161 kg
 Gross Volume - Hacim : 1,05 m³
 Electrical Inlet - Elektrik Girişi : 400 V 3N PE
 Smooth - Düz : 1/1
 Chrome Plated - Krom Plate : 1/1
 Price - Fiyat : 2.144 €

**G9I210E-C-W** ⚡

Dim(mm)LxDxH - Ebat (mm): 800x900x900
 Power - Güç : 12 kW
 Gross Weight - Ağırlık : 156 kg
 Gross Volume - Hacim : 1,05 m³
 Electrical Inlet - Elektrik Girişi : 400 V 3N PE
 Ribed - Oluklu : 1/1
 Chrome Plated - Krom Plate : 1/1
 Price - Fiyat : 2.288 €



G9I210E-C ⚡

Dim(mm)LxDxH - Ebat (mm): 800x900x900
 Power - Güç : 12 kW
 Gross Weight - Ağırlık : 164 kg
 Gross Volume - Hacim : 1,05 m³
 Electrical Inlet - Elektrik Girişi : 400 V 3N PE
 Ribed - Oluklu : 1/1
 Chrome Plated - Krom Plate : 1/1
 Price - Fiyat : 2.394 €

**G9I220E-C-W** ⚡

Dim(mm)LxDxH - Ebat (mm): 800x900x900
 Power - Güç : 12 kW
 Gross Weight - Ağırlık : 156 kg
 Gross Volume - Hacim : 1,05 m³
 Smooth - Düz : 1/2
 Ribed - Oluklu : 1/2
 Chrome Plated - Krom Plate : 1/1
 Electrical Inlet - Elektrik Girişi : 400 V 3N PE
 Price - Fiyat : 2.212 €

**G9I220E-C** ⚡

Dim(mm)LxDxH - Ebat (mm): 800x900x900
 Power - Güç : 12 kW
 Gross Weight - Ağırlık : 164 kg
 Gross Volume - Hacim : 1,05 m³
 Smooth - Düz : 1/2
 Ribed - Oluklu : 1/2
 Chrome Plated - Krom Plate : 1/1
 Electrical Inlet - Elektrik Girişi : 400 V 3N PE
 Price - Fiyat : 2.318 €



G9I100G-C-W 

Dim(mm)LxDxH - Ebat (mm): 400x900x900
 Power - Güç : 9 kW
 Gross Weight - Ağırlık : 78 kg
 Gross Volume - Hacim : 0,53 m³
 Gas Inlet - Gaz Girişi : R ½ "
 Smooth - Düz : 1/1
 Chrome Plated - Krom Plate : 1/1
 Price - Fiyat : 1.355 €



G9I100G-C 

Dim(mm)LxDxH - Ebat (mm): 400x900x900
 Power - Güç : 9 kW
 Gross Weight - Ağırlık : 82 kg
 Gross Volume - Hacim : 0,53 m³
 Gas Inlet - Gaz Girişi : R ½ "
 Smooth - Düz : 1/1
 Chrome Plated - Krom Plate : 1/1
 Price - Fiyat : 1.408 €



G9I110G-C-W 

Dim(mm)LxDxH - Ebat (mm): 400x900x900
 Power - Güç : 9 kW
 Gross Weight - Ağırlık : 82 kg
 Gross Volume - Hacim : 0,53 m³
 Gas Inlet - Gaz Girişi : R ½ "
 Ribed - Oluklu : 1/1
 Chrome Plated - Krom Plate : 1/1
 Price - Fiyat : 1.568 €



G9I110G-C 

Dim(mm)LxDxH - Ebat (mm): 400x900x900
 Power - Güç : 9 kW
 Gross Weight - Ağırlık : 86 kg
 Gross Volume - Hacim : 0,53 m³
 Gas Inlet - Gaz Girişi : R ½ "
 Ribed - Oluklu : 1/1
 Chrome Plated - Krom Plate : 1/1
 Price - Fiyat : 1.621 €

**G9I200G-C-W** 

Dim(mm)LxDxH - Ebat (mm): 800x900x900
 Power - Güç : 18 kW
 Gross Weight - Ağırlık : 127 kg
 Gross Volume - Hacim : 1,05 m³
 Gas Inlet - Gaz Girişi : R ½ "
 Smooth - Düz : 1/1
 Chrome Plated - Krom Plate : 1/1
 Price - Fiyat : 1.931 €

**G9I200G-C** 

Dim(mm)LxDxH - Ebat (mm): 800x900x900
 Power - Güç : 18 kW
 Gross Weight - Ağırlık : 135 kg
 Gross Volume - Hacim : 1,05 m³
 Gas Inlet - Gaz Girişi : R ½ "
 Smooth - Düz : 1/1
 Chrome Plated - Krom Plate : 1/1
 Price - Fiyat : 2.037 €



G9I210G-C-W 

Dim(mm)LxDxH - Ebat (mm): 800x900x900
Power - Güç : 18 kW
Gross Weight - Ağırlık : 142 kg
Gross Volume - Hacim : 1,05 m³
Gas Inlet - Gaz Girişi : R ½ "
Ribed - Oluklu : 1/1
Chrome Plated - Krom Plate : 1/1
Price - Fiyat : 2.220 €



G9I210G-C 

Dim(mm)LxDxH - Ebat (mm): 800x900x900
Power - Güç : 18 kW
Gross Weight - Ağırlık : 150 kg
Gross Volume - Hacim : 1,05 m³
Gas Inlet - Gaz Girişi : R ½ "
Ribed - Oluklu : 1/1
Chrome Plated - Krom Plate : 1/1
Price - Fiyat : 2.326 €



G9I220G-C-W 

Dim(mm)LxDxH - Ebat (mm): 800x900x900

Power - Güç : 18 kW

Gross Weight - Ağırlık : 142 kg

Gross Volume - Hacim : 1,05 m³

Gas Inlet - Gaz Girişi : R ½ "

Smooth - Düz : 1/2

Ribed - Oluklu : 1/2

Chrome Plated - Krom Plate : 1/1

Price - Fiyat : 2.073 €

**G9I220G-C** 

Dim(mm)LxDxH - Ebat (mm): 800x900x900

Power - Güç : 18 kW

Gross Weight - Ağırlık : 150 kg

Gross Volume - Hacim : 1,05 m³

Gas Inlet - Gaz Girişi : R ½ "

Smooth - Düz : 1/2

Ribed - Oluklu : 1/2

Chrome Plated - Krom Plate : 1/1

Price - Fiyat : 2.179 €

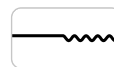

GENERAL FEATURES

- Stainless steel body
- Quick easy cleaning
- Safety gas valve
- Ergonomic design
- Adjustable legs
- Durable
- High efficiency burner
- Available lpg or natural gas

GENEL ÖZELLİKLER

- Paslanmaz çelik gövde
- Kolay temizlenebilir hijyenik
- Emniyet ventili gaz valfi
- Ergonomik tasarım
- Ayarlanabilir ayaklar
- Dayanıklı
- Yüksek verimli brülör
- Lpg ve Doğal Gazla uyumlu

G9F100E ⚡

Dim(mm)LxDxH – Ebat (mm):	400x900x900
Power – Güç	: 18 kW
Gross Weight – Ağırlık	: 64 kg
Gross Volume – Hacim	: 0,53 m ³
Electrical Inlet – Elektrik Girişi	: 400 V 3N PE
Basket Size – Sepet Ölçüsü	: 140x320x185 (2 pcs)
Capacity – Kapasite	: 22 lt
Price – Fiyat	: 1.347 €



G9F100G ⚡

Dim(mm)LxDxH – Ebat (mm):	400x900x900
Power – Güç	: 18 kW
Gross Weight – Ağırlık	: 70,5 kg
Gross Volume – Hacim	: 0,56 m ³
Gas Inlet – Gaz Girişi	: R 1/2 "
Basket Size – Sepet Ölçüsü	: 140x350x130 (2 pcs)
Capacity – Kapasite	: 19 lt
Price – Fiyat	: 1.582 €



PRODUCT SPECIFICATIONS

- Safety thermostat
- Single or double container models
- Scratch-proof enamelled back iron cast chimney
- Fryer with storage cabinet
- Piezo spark ignition
- Thermostat temperature control
- Stainless steel baskets
- Adjustable temperature
- High efficient gas combustion system
- Operation and heating control indicator lights
- Stainless steel tube heaters (For electrical products)
- Easy clean with movable resistances

ÜRÜN DETAYLARI

- Emniyet termostatlı
- Tekli veya çift havuzlu modelleri
- Çizilmez ve paslanmaz emaye dökme demir baca
- Kapaklı alt dolap
- Piezoelektrik ateşlemeli brülör
- Termostatlı sıcaklık kontrolü
- Paslanmaz sepetler
- Ayarlanabilir ısı derecesi
- Yüksek verim sağlayan gaz yanış sistemi
- Çalıştırma ve sıcaklık sinyal lambaları
- Paslanmaz boru rezistans (Elektrikli ürünler için)
- Hareketli rezistanslar ile kolay temizlenebilirlik

G9F200E ⚡

Dim(mm)LxDxH - Ebat (mm)	: 800x900x900
Power - Güç	: 36 kW
Gross Weight - Ağırlık	: 106 kg
Gross Volume - Hacim	: 1,05 m ³
Electrical Inlet - Elektrik Girişi	: 400 V 3N PE
Basket Size - Sepet Ölçüsü	: 140x320x185 (4 pcs)
Capacity - Kapasite	: 2x22 lt
Price - Fiyat	: 2.072 €

**G9F200G** 🔥

Dim(mm)LxDxH - Ebat (mm)	: 800x900x900
Power - Güç	: 36 kW
Gross Weight - Ağırlık	: 133 kg
Gross Volume - Hacim	: 1,05 m ³
Gas Inlet - Gaz Girişi	: R ½ "
Basket Size - Sepet Ölçüsü	: 140x350x130 (4 pcs)
Capacity - Kapasite	: 2x19 lt
Price - Fiyat	: 2.629 €



GENERAL FEATURES

- Stainless steel body
- Quick easy cleaning
- Ergonomic design
- Adjustable legs
- Durable

GENEL ÖZELLİKLER

- Paslanmaz çelik gövde
- Kolay temizlenebilir hijyenik
- Ergonomik tasarım
- Ayarlanabilir ayaklar
- Uzun ömürlü

G9TD200E ⚡

Dim(mm)LxDxH - Ebat (mm):	800x900x900
Power - Güç	: 12 kW
Gross Weight - Ağırlık	: 157 kg
Gross Volume - Hacim	: 1,05 m ³
Electrical Inlet - Elektrik Girişi	: 400 V 3N PE
Capacity - Kapasite	: 80 lt
Water Inlet - Su Girişi	: 1/2
Price - Fiyat	: 3.414 €



G9TD200G 🔥

Dim(mm)LxDxH - Ebat (mm):	800x900x900
Power - Güç	: 20,5 kW
Gross Weight - Ağırlık	: 167 kg
Gross Volume - Hacim	: 1,08 m ³
Electrical Inlet - Elektrik Girişi	: 230V 1N PE
Gas Inlet - Gaz Girişi	: R 1/2
Capacity - Kapasite	: 80 lt
Water Inlet - Su Girişi	: 1/2
Price - Fiyat	: 3.403 €



G9TD201E ⚡

Dim(mm)LxDxH - Ebat (mm):	1200x900x900
Power - Güç	: 20 kW
Gross Weight - Ağırlık	: 232,5 kg
Gross Volume - Hacim	: 1,52 m ³
Electrical Inlet - Elektrik Girişi	: 400 V 3N PE
Capacity - Kapasite	: 120 lt
Water Inlet -Su Girişi	: 1/2
Price - Fiyat	: 4.463 €

**G9TD201G** 🔥

Dim(mm)LxDxH - Ebat (mm):	1200x900x900
Power - Güç	: 30 kW
Gross Weight - Ağırlık	: 210 kg
Gross Volume - Hacim	: 1,52 m ³
Electrical Inlet - Elektrik Girişi	: 230 V 1N PE
Gas Inlet - Gaz Girişi	: R 1/2 "
Water Inlet -Su Girişi	: 1/2
Capacity - Kapasite	: 120 lt
Price - Fiyat	: 4.212 €

**PRODUCT SPECIFICATIONS**

- Stainless steel cooking pan
- Safety switches activates, when the tilting starts
- Safety thermostat
- Pilot light and valve with thermocouple
- Piezo spark ignition
- Water fill pipe controlled from front panel
- Self hinged lid 200 mm depth stainless steel pan
- Scratch-proof enamelled iron cast chimney
- Thermostat temperature control
- Tubular burner under tank
- Adjustable heating system 50°C - 300°C
- Manual boost system

ÜRÜN DETAYLARI

- Paslanmaz pişirme kazanı.
- Pişirme kazanı kaldırıldığında çalışmayı durduran emniyet swichi
- Emniyet termostadı.
- Pilot alevi ve termokupullu valf
- Piezoelektrik ateşlemeli brülör
- Ön panelden kontrol edilen su doldurma borusu
- Havuz kapağı kendinden menteşeli paslanmaz havuz derinliği 200 mm
- Çizilmez ve paslanmaz emaye dökme demir baca
- Termostatik sıcaklık kontrolü
- Pişirme havuzu altında paslanmaz boru ısıtıcılar
- Ayarlanabilir sıcaklık, 50°C - 300°C
- Volanlı manuel kaldırma

GENERAL FEATURES

- Stainless steel body
- Quick easy cleaning
- Ergonomic design
- Adjustable legs
- Durable

GENEL ÖZELLİKLER

- Paslanmaz çelik gövde
- Kolay temizlenebilir hijyenik
- Ergonomik tasarım
- Ayarlanabilir ayaklar
- Uzun ömürlü

G9KT200E ⚡

Dim(mm)LxDxH - Ebat (mm) :	800x900x900
Power - Güç :	12 kW
Gross Weight - Ağırlık :	145 kg
Gross Volume - Hacim :	1,05 m ³
Electrical Inlet - Elektrik Girişi :	400 V 3N PE
Capacity - Kapasite :	150 lt
Water Inlet -Su Girişi :	1/2
Price - Fiyat :	4.256 €



G9KT200G 🔥

Dim(mm)LxDxH - Ebat (mm) :	800x900x900
Power - Güç :	20,5 kW
Gross Weight - Ağırlık :	172 kg
Gross Volume - Hacim :	1,05 m ³
Gas Inlet - Gaz Girişi :	R 1/2 "
Electrical Inlet - Elektrik Girişi :	230V 1 N PE
Capacity - Kapasite :	150 lt
Water Inlet -Su Girişi :	1/2
Price - Fiyat :	4.200 €



G9KT200G-D 🔥

Dim(mm)LxDxH - Ebat (mm) :	800x900x900
Power - Güç :	20 kW
Gross Weight - Ağırlık :	129 kg
Gross Volume - Hacim :	1,05 m ³
Gas Inlet - Gaz Girişi :	R 1/2 "
Capacity - Kapasite :	150 lt
Water Inlet -Su Girişi :	1/2
Price - Fiyat :	3.251 €



G9KT201E ⚡

Dim(mm)LxDxH - Ebat (mm)	: 1200x900x900
Power - Güç	: 24 kW
Gross Weight - Ağırlık	: 271 kg
Gross Volume - Hacim	: 1,52 m ³
Electrical Inlet - Elektrik Girişi	: 400 V 3N PE
Capacity - Kapasite	: 250 lt
Water Inlet - Su Girişi	: 1/2
Price - Fiyat	: 4.935 €

G9KT201G 🔥

Dim(mm)LxDxH - Ebat (mm)	: 1200x900x900
Power - Güç	: 30 kW
Gross Weight - Ağırlık	: 282 kg
Gross Volume - Hacim	: 1,52 m ³
Gas Inlet - Gaz Girişi	: R ½ "
Electrical Inlet - Elektrik Girişi	: 230V 1 N PE
Capacity - Kapasite	: 250 lt
Water Inlet - Su Girişi	: 1/2
Price - Fiyat	: 4.651 €

G9KT201G-D 🔥

NEW

Dim(mm)LxDxH - Ebat (mm)	: 1200x900x900
Power - Güç	: 30 kW
Gross Weight - Ağırlık	: 212,5 kg
Gross Volume - Hacim	: 1,52 m ³
Gas Inlet - Gaz Girişi	: R ½ "
Capacity - Kapasite	: 250 lt
Water Inlet - Su Girişi	: 1/2
Price - Fiyat	: 4.210 €

PRODUCT SPECIFICATIONS

- Water inlet and drain taps located on front panel
- Direct or indirect heating
- High efficiency and minimum maintenance
- Durable and minimum maintenance provided by using oil in jacket delete
- Safety thermostat
- 3mm thick pressed pool
- 2" special discharge valve
- Thermostatic control (G9KT201E/G)
- Safety thermostat (G9KT201E/G)
- Valve with pilot light and thermocouple (G9KT201G/G-D)
- Burner with piezoelectric ignition (G9KT201G)
- Pool cover self-hinged

ÜRÜN DETAYLARI

- Su doldurma musluğu ve tahliye vanası
- Direkt veya indirekt ısıtma
- Yüksek verim sağlayan yağlı ısıtma
- Çeketler arasında kullanılan yağ sayesinde minimum bakım uzun ömür
- Emniyet termostatı
- 3mm kalınlığında pres baskı havuz
- 2" özel boşaltma vanası
- Termostatik kontrol (G9KT201E/G)
- Emniyet termostatı (G9KT201E/G)
- Pilot alevi ve termokupullu valf (G9KT201G/G-D)
- Piezoelektrik ateşlemeli brülör (G9KT201G)
- Havuz kapağı kendinden menteşeli

GENERAL FEATURES

- Stainless steel body
- Easy to clean and hygienic
- Ergonomic design
- Adjustable legs
- Durable
- Casting suitable for special wok pan

GENEL ÖZELLİKLER

- Paslanmaz çelik gövde
- Kolay temizlenebilir hijyenik
- Ergonomik tasarım
- Ayarlanabilir ayaklar
- Uzun ömürlü
- Özel wok tavaına uygun dökümler

G9W100G

Dim(mm)LxDxH - Ebat (mm):	400x900x900
Power - Güç	: 15 kW
Gross Weight - Ağırlık	: 77 kg
Gross Volume - Hacim	: 0,53 m ³
Gas Inlet - Gaz Girişi	: R ½ "
Price - Fiyat	: 904 €



PRODUCT SPECIFICATIONS

- Iron cast burners, with chromium-nickel burner-head
- Well clean with removanble iron casts.

ÜRÜN DETAYLARI

- Krom-nikel kaplı , yarıklı döküm brülör
- Sökülebilir dökümler ile kolay temizlik

GENERAL FEATURES

- Gn containers are excluded
- Stainless steel body
- Quick easy cleaning
- Ergonomic design
- Adjustable legs
- Durable
- Drain valve

G9S100E-W ⚡

Dim(mm)LxDxH – Ebat (mm): 400x900x900
Power – Güç : 1 kW
Gross Weight – Ağırlık : 46,5 kg
Gross Volume – Hacim : 0,53 m³
Electrical Inlet – Elektrik Girişi : 230 V 1N PE
Tank Capacity – Havuz Kapasitesi: GN 2/3 150 mm x 1 – GN 1/3 150 mm x 1
Price – Fiyat : 784 €

G9S100E ⚡

Dim(mm)LxDxH – Ebat (mm): 400x900x900
Power – Güç : 1 kW
Gross Weight – Ağırlık : 50,5 kg
Gross Volume – Hacim : 0,53 m³
Electrical Inlet – Elektrik Girişi : 230 V 1N PE
Tank Capacity – Havuz Kapasitesi: GN 2/3 150 mm x 1 – GN 1/3 150 mm x 1
Price – Fiyat : 837 €

PRODUCT SPECIFICATIONS

- With pilot flame system (gas)
- Thermostatic gas valve (gas) (30-90)
- Specially designed stainless burner (gas)
- Piezo ignition control (gas)
- Heat insulated insulation body sheet construction (gas)
- GN containers not included
- 1/1 press pressure bain-marie with pool
- Well design according to GN container dimension
- Scratch-proof enamel coated cast iron back grate
- Storage cabinet
- Thermostat temperature control
- Silicon tube heaters under the tank
- Indicator lights

ÜRÜN DETAYLARI

- Pilot alev sistemli (gazlı)
- Termostatik gaz valfi (gazlı) (30-90)
- Özel tasarlanmış paslanmaz brülör (gazlı)
- Piezo ateşleme kontrolü (gazlı)
- Isı yalıtımlı izolasyon gövde sac konstrüksiyon (gazlı)
- GN küvetler dahil değildir
- 1/1 pres baskı benmari havuzlu
- Gn ölçülerine uygun ısıtma havuzu
- Çizilmez ve paslanmaz emaye dökme demir baca
- Kapaklı alt dolap
- Termostatik ısı kontrolü
- Havuz altında silikon tüp rezistansları
- Uyarı ışıkları



G9S200E-W ⚡

Dim(mm)LxDxH - Ebat (mm): 800x900x900
 Power - Güç : 2 kW
 Gross Weight - Ağırlık : 78 kg
 Gross Volume - Hacim : 1,05 m³
 Electrical Inlet - Elektrik Girişi : 230 V 1N PE
 Tank Capacity - Havuz Kapasitesi: GN 2/3 150 mm x 2 - GN 1/3 150 mm x 2
 Price - Fiyat : 952 €

**G9S200G** 🔥

Dim(mm)LxDxH - Ebat (mm): 800x900x900
 Power - Güç : 6 kW
 Gross Weight - Ağırlık : 105 kg
 Gross Volume - Hacim : 1,05 m³
 Gas Inlet - Gaz Girişi : R 1/2 "
 Tank Capacity - Havuz Kapasitesi: GN 2/3 150 mm x 2 - GN 1/3 150 mm x 2
 Price - Fiyat : 1.518 €

**G9S200E** ⚡

Dim(mm)LxDxH - Ebat (mm): 800x900x900
 Power - Güç : 2 kW
 Gross Weight - Ağırlık : 86 kg
 Gross Volume - Hacim : 1,05 m³
 Electrical Inlet - Elektrik Girişi : 230 V 1N PE
 Tank Capacity - Havuz Kapasitesi: GN 2/3 150 mm x 2 - GN 1/3 150 mm x 2
 Price - Fiyat : 1.058 €



GENERAL FEATURES

- Stainless steel body
- Quick easy cleaning
- Safety valf with relief
- Ergonomic design
- Adjustable legs
- Durable
- Available for lpg or natural gas

GENEL ÖZELLİKLER

- Paslanmaz çelik gövde
- Kolay temizlenebilir hijyenik
- Emniyet ventili gaz valfi
- Ergonomik tasarım
- Ayarlanabilir ayaklar
- Uzun ömürlü
- Doğalgaz ve Lpg ile çalışmaya uygundur.

G9L100G 🔥

Dim(mm)LxDxH - Ebat (mm):	400x900x900
Power - Güç	: 11 kW
Gross Weight - Ağırlık	: 84,5 kg
Gross Volume - Hacim	: 0,53 m ³
Gas Inlet - Gaz Girişi	: R ½ "
Price - Fiyat	: 1.077 €



G9L200G 🔥

Dim(mm)LxDxH - Ebat (mm):	800x900x900
Power - Güç	: 22 kW
Gross Weight - Ağırlık	: 136 kg
Gross Volume - Hacim	: 1,05 m ³
Gas Inlet - Gaz Girişi	: R ½ "
Price - Fiyat	: 1.828 €



PRODUCT SPECIFICATIONS

- Heavy duty bottom iron casts
- Consistent cooking surface
- Stainless steel oil collection inside cabinet
- Steel "v" shaped mobile cooking grate
- Large sized draining drawer
- Piezo spark ignition
- Two independent cooking surfaces
- Body insulated to prevent overheating and energy loss
- Sloped cooking surface for easy maintenance and cleaning with drain
- High mineral pumice lava stones that trap heat for a long time

ÜRÜN DETAYLARI

- Homojen pişirme yüzeyi
- Dolap içerisine yerleştirilmiş paslanmaz çelik yağ toplama çekmecesini
- Çelik "v" şeklinde hareketli pişirme ızgarası
- Atık yağ haznesi piezoelektrik ateşlemeli brülör
- İki bağımsız pişirme bölgesi
- Çevre saçlarının ısınması ve ısı kayıplarını minimum düzeye indiren izolasyon
- Kolay ve rahat temizlik için hafif eğimli pişirme yüzeyi, sıvı boşaltma delikli
- Isıyı uzun süre hapsedebilen, yüksek mineralli pomza lavtaşları

GENERAL FEATURES

- Stainless steel body
- Quick easy cleaning
- Ergonomic design
- Adjustable legs
- Durable

GENEL ÖZELLİKLER

- Paslanmaz çelik gövde
- Kolay temizlenebilir hijyenik
- Ergonomik tasarım
- Ayarlanabilir ayaklar
- Uzun ömürlü

G9T100N-W

Dim(mm)LxDxH - Ebat (mm): 400x900x900
Gross Weight - Ağırlık : 36,5 kg
Gross Volume - Hacim : 0,53 m³
Price - Fiyat : 416 €



G9T100N

Dim(mm)LxDxH - Ebat (mm): 400x900x900
Gross Weight - Ağırlık : 40,5 kg
Gross Volume - Hacim : 0,53 m³
Price - Fiyat : 469 €



PRODUCT SPECIFICATIONS

- Base cabinet with door - without door
- Scratch-proof enamelled iron cast chimney

ÜRÜN DETAYLARI

- Kapaklı - kapaksız alt dolap
- Çizilmez ve paslanmaz emaye dökme demir baca

G9T200N-W

Dim(mm)LxDxH - Ebat (mm): 800x900x900
Gross Weight - Ağırlık : 56 kg
Gross Volume - Hacim : 1,05 m³
Price - Fiyat : 462 €

**G9T200N**

Dim(mm)LxDxH - Ebat (mm): 800x900x900
Gross Weight - Ağırlık : 64 kg
Gross Volume - Hacim : 1,05 m³
Price - Fiyat : 568 €

**G7/9100-200-201 Kapı - Door
095.100.0007**

Features : Cabinet Door
Price- Fiyat : 55 €



GENERAL FEATURES

- Stainless steel body
- Easy to clean and hygienic
- Ergonomic design
- Adjustable legs
- Water drawer
- Durable

G9V100G

NEW

Dim(mm)LxDxH - Ebat (mm):	400x900x900
Power - Güç	: 11 kW
Gross Weight - Ağırlık	: 114 kg
Gross Volume - Hacim	: 0,53 m ³
Gas Inlet - Gaz Girişi	: R ½ "
Price - Fiyat	: 1.404 €



G9V200G

NEW

Dim(mm)LxDxH - Ebat (mm):	800x900x900
Power - Güç	: 22 kW
Gross Weight - Ağırlık	: 220 kg
Gross Volume - Hacim	: 1,05 m ³
Gas Inlet - Gaz Girişi	: R ½ "
Price - Fiyat	: 2.289 €



PRODUCT SPECIFICATIONS

- Thanks to water reservoir under cast cooking surface, vaporization is provided during cooking process and dehydration of food being cooked is prevented.
- Special design griddles on cooking surface can be removed
- The water reservoir that can be interfered from front face has drawers and it can be removed easily.
- Residuary oil flows through cooking grill and it goes to the water reservoir. So inflammation of oil is prevented
- This version has two separate firing zones.
- Isolation that minimizes heating of periphery metal sheet and heat abduction.
- Mouldings that are designed specially and that breaks fires.
- Heavy duty iron castings

ÜRÜN DETAYLARI

- Döküm pişirme yüzeyinin altındaki su haznesi sayesinde pişirme işlemi sırasında buharlaşma sağlanır ve pişen yiyeceklerin kuruması önlenir.
- Özel tasarım çıkarılabilir ızgaralar
- Ön yüzünden müdahale edilebilen su haznesi çekmeceli olup kolaylıkla çıkarılabilir.
- Artık yağ, pişirme ızgarasından geçer ve su haznesine gider. Böylece yağın alevlenmesi önlenir
- İki ayrı pişirme bölgesi
- Çevre sacının ısınmasını ve ısı kaybını en aza indiren izolasyon.
- Özel tasarlanmış ve yangını söndüren pervazlar.
- Sanayi tipi demir dökümler

Fryer Basket/Fritöz Sepeti

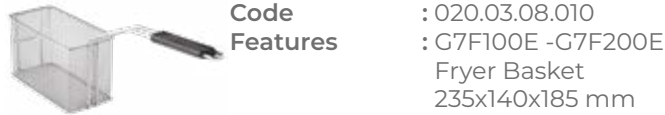
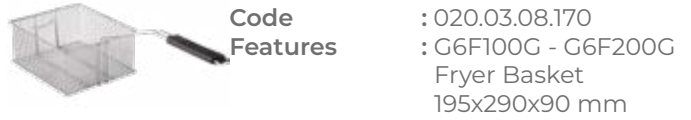
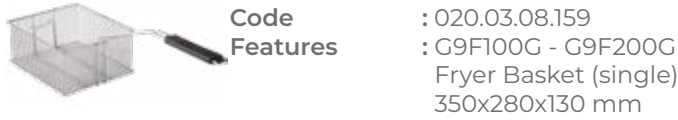
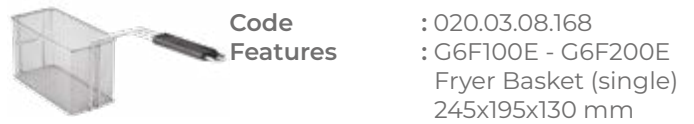
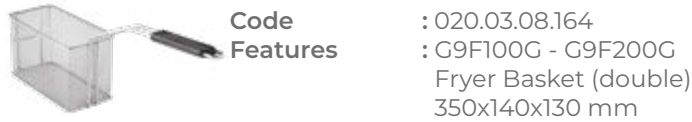
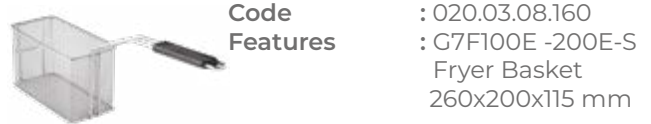
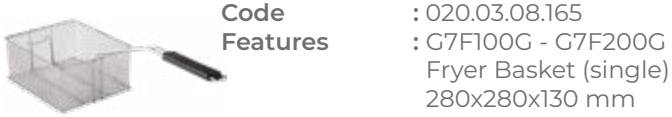
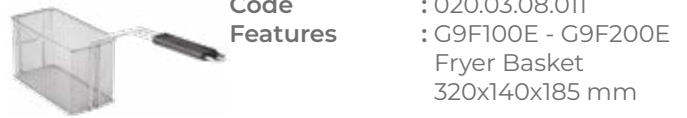
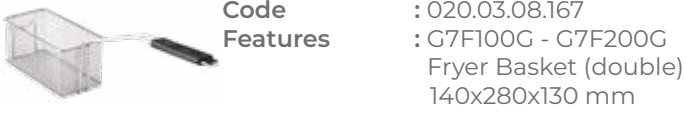

Please contact for the accessories prices
Aksesuar fiyatları için lütfen iletişime geçiniz

Pasta Cookers Basket/Makarna Pişirici Sepeti

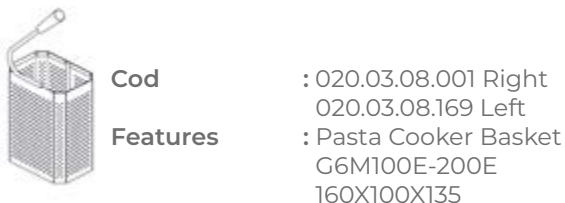
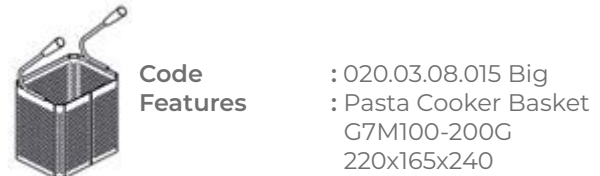
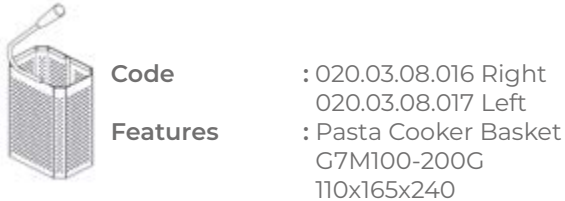
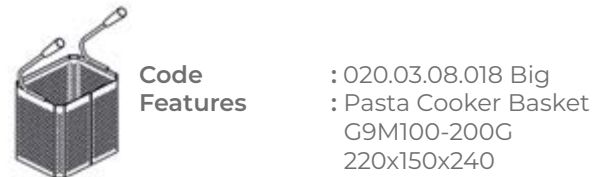
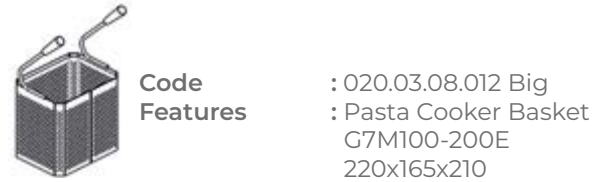



Code : 095.100.0020
Features : Reduction For 700 Series



Code : 095.100.0021
Features : Reduction For 900 Series



Code : 095.100.0018 - 7/9SCL
(G7/9L 100/200G)
Features : Scraper For Lavastone



Code : 040.04.02.150
Features : Lavastone Charcoal



Code : 020.03.10.056
Features : Extra enameled coated GN 2/1x65 mm tray for all ranges



Code : 095.100.0019 -7/9SCI
(G7/9I 110-220-210)
Features : Scraper For Griddle



Code : 020.02.04.251
Features : Extra grid for all ranges 2 / 1 Grid -Size: 535x590 mm



Code : 020.03.10.052
Features : Extra S/S GN 2/1x65 mm tray for all series

KUSINA®

Cooking Series • Klasik Pişirici Serisi



Classic Cooking/Stock Pot Stoves • Yer Ocakları

GENERAL FEATURES

- Stainless steel body
- Easy to and clean and hygienic
- Ergonomic design
- Durable
- Heavy duty iron casts
- high and low flame control

GENEL ÖZELLİKLER

- Paslanmaz çelik gövde
- Kolay temizlenebilir hijyenik
- Ergonomik tasarım
- Uzun ömürlü
- Yüksek ısıya dayanıklı özel dökümler
- Yüksek ve düşük alev kontrollü

GRCYO12NGLPG Stove Single Ring/Tek Yanırlı Yer Ocağı

Dim(mm)LxDxH - Ebat (mm):	400x500x500
Power - Güç	: 12 kW
Gross Weight - Ağırlık	: 27 kg
Gross Volume - Hacim	: 0,20 m ³
Gas Inlet - Gaz Girişi	: R ½ "
Price - Fiyat	: 390 €



GRCYO15LPG GRCYO15NG

Stove Two Ring/Çift Yanırlı Yer Ocağı

Dim(mm)LxDxH - Ebat (mm):	600x800x500
Power - Güç	: 15 kW
Gross Weight - Ağırlık	: 58 kg
Gross Volume - Hacim	: 0,30 m ³
Gas Inlet - Gaz Girişi	: R ½ "
Price - Fiyat	: 457 €



GRCYO24NGLPG Stove Two Ring/Çift Yanırlı Yer Ocağı

Dim(mm)LxDxH - Ebat (mm):	600x800x500
Power - Güç	: 24 kW
Gross Weight - Ağırlık	: 52 kg
Gross Volume - Hacim	: 0,30 m ³
Gas Inlet - Gaz Girişi	: R ½ "
Price - Fiyat	: 535 €



Classic Cooking/Stock Pot Stoves • Yer Ocakları

GRCYO28LPG GRCYO28NG

🔥 **Stove Tree Ring/Üç Yanırlı Yer Ocağı**

Dim(mm)LxDxH - Ebat (mm): 700x850x500
Power - Güç : 28 kW
Gross Weight - Ağırlık : 68 kg
Gross Volume - Hacim : 0,30 m³
Gas Inlet - Gaz Girişi : R ½ "
Price - Fiyat : 685 €



GRCYO32LPG GRCYO32NG

🔥 **Stove Four Ring/Dört Yanırlı Yer Ocağı**

Dim(mm)LxDxH - Ebat (mm): 700x850x500
Power - Güç : 32 kW
Gross Weight - Ağırlık : 70 kg
Gross Volume - Hacim : 0,30 m³
Gas Inlet - Gaz Girişi : R ½ "
Price - Fiyat : 707 €



GRCYO4E

⚡ **Electrical Stove /Elektrikli Ocak**

Dim(mm)LxDxH - Ebat (mm): 550x550x500
Power - Güç : 4 kW
Gross Weight - Ağırlık : 40 kg
Gross Volume - Hacim : 0,20 m³
Electrical Inlet - Elektrik Girişi : 400 V 3N PE
Price - Fiyat : 668 €



Classic Cooking/Range Series • Kuzine Serisi

GENERAL FEATURES

- Stainless steel body
- Easy to clean and hygienic
- Safety gas valve
- Ergonomic design
- Adjustable legs
- Durable
- High efficiency burner
- Isolated oven

GENEL ÖZELLİKLER

- Paslanmaz çelik gövde
- Kolay temizlenebilir hijyenik
- Emniyet ventili gaz valfi
- Ergonomik tasarım
- Ayarlanabilir ayaklar
- Uzun ömürlü
- Yüksek verimli brülör
- İzolasyonlu fırın

G5K200G

Dim(mm)LxDxH - Ebat (mm)	: 800x575x900
Burners kW - Brülör kW	: 2x9,5 kW
Power - Güç	: 19 kW
Gross Weight - Ağırlık	: 72 kg
Gross Volume - Hacim	: 1,18 m ³
Gas Inlet - Gaz Girişi	: R ½ "
Price - Fiyat	: 942 €

Door- Kapı (Optional-Opsiyonel)

Code-Kod : 095.100.00.38

Price - Fiyat : 55 € / 1 pcs



G5K201G

Dim(mm)LxDxH - Ebat (mm)	: 1200x575x900
Burners kW - Brülör kW	: 3x9,5 kW
Power - Güç	: 28,5 kW
Gross Weight - Ağırlık	: 115 kg
Gross Volume - Hacim	: 1,40 m ³
Gas Inlet - Gaz Girişi	: R ½ "
Price - Fiyat	: 1.239 €

Door- Kapı (Optional-Opsiyonel)

Code-Kod : 095.100.00.38

Price - Fiyat : 55 € / 1 pcs



G5K211G

Dim(mm)LxDxH - Ebat (mm)	: 1200x575x900
Burners kW - Brülör kW	: 3x9,5
Power - Güç	: 32 kW
Gross Weight - Ağırlık	: 147 kg
Gross Volume - Hacim	: 1,40 m ³
Gas Inlet - Gaz Girişi	: R ½ "
Tray Dimensions - Tepsi boyutları	: GN 1/1
Oven kW - Fırın kW	: 4,5 kW
Price - Fiyat	: 1.794 €



Classic Cooking/Range • Kuzineler

GENERAL FEATURES

- Stainless steel body
- Easy to clean and hygienic
- Ergonomic design
- Adjustable legs
- Durable
- High efficiency burner
- Gas areavailable heavy duty top cast

GENEL ÖZELLİKLER

- Paslanmaz çelik gövde
- Kolay temizlenebilir hijyenik
- Ergonomik tasarım
- Ayarlanabilir ayaklar
- Uzun ömürlü
- Yüksek verimli brülör
- Gazlı ağır hizmet tipi döküm mevcuttur

GRC10KZ30

Dim(mm)LxDxH - Ebat (mm):	1000x1000x850
Burners kW - Brülör kW	: 4 x 8,5 kW
Power - Güç	: 39,85 kW
Gross Weight - Ağırlık	: 120 kg
Gross Volume - Hacim	: 1,10 m ³
Gas Inlet - Gaz Girişi	: R ½ "
Oven kW - Fırın kW	: 6 kW
Price - Fiyat	: 2.023 €



GRC15KZ35

Dim(mm)LxDxH - Ebat (mm):	1500x1000x850
Burners kW - Brülör kW	: 2 x 8,5 kW + 1x10 kW
Power - Güç	: 33 kW
Gross Weight - Ağırlık	: 170 kg
Gross Volume - Hacim	: 1,60 m ³
Gas Inlet - Gaz Girişi	: R ½ "
Oven kW - Fırın kW	: 9 kW
Price - Fiyat	: 2.337 €



GRC20KZ50-LPG GRC20KZ50-NG

Dim(mm)LxDxH - Ebat (mm):	2000x1000x850
Burners kW - Brülör kW	: 2x8,5 kW + 2x10 kW
Power - Güç	: 49 kW
Gross Weight - Ağırlık	: 230 kg
Gross Volume - Hacim	: 2,10 m ³
Gas Inlet - Gaz Girişi	: R ½ "
Tray Dimensions - Tepsi boyutları:	GN 2/1x2
Oven kW - Fırın kW	: 2x6 kW
Price - Fiyat	: 3.048 €



G10K200G 

Dim(mm)LxDxH - Ebat (mm): 1000x700x900
Burners kW - Brülör kW : 8.5 kW x 2
Power - Güç : 17 kW
Gross Weight - Ağırlık : 56 kg
Gross Volume - Hacim : 0,88 m³
Gas Inlet - Gaz Girişi : R ½ "
Price - Fiyat : 992 €



G10K200G-D 

Dim(mm)LxDxH - Ebat (mm): 1000x700x900
Burners kW - Brülör kW : 8.5 kW x 2
Power - Güç : 17 kW
Gross Weight - Ağırlık : 86 kg
Gross Volume - Hacim : 0,88 m³
Gas Inlet - Gaz Girişi : R ½ "
Price - Fiyat : 1389 €



Electrical Boiling Tops/Elektrikli Set Üstü Ocak

GENERAL FEATURES

- Stainless steel handle
- 0-6 position switch.
- Adjustable legs
- Movable hot plate mechanisms
- 2mm 304 top plate
- 2mm Galvanized inner construction
- Cleanable grease drawer

GENEL ÖZELLİKLER

- Paslanmaz çelik sap
- 0-6 konum anahtarı
- Ayarlanabilir ayaklar
- Hareketli sıcak pleyt mekanizmaları
- 2mm 304 üst plaka
- 2mm galvanizli iç yapı
- Temizlenebilir yağ çekmecesini

G7K100E-S-R ⚡

Dim(mm)LxDxH - Ebat (mm):	400x730x300
Plates - Isıtıcı Pleyt	: 2 x 3 kW
Power - Güç	: 6 kW
Gross Weight - Ağırlık	: 38 kg
Gross Volume - Hacim	: 1,10 m ³
Electrical Inlet - Elektrik Girişi	: 400V 3N PE
Price - Fiyat	: 1.000 €



G7K200E-S-R ⚡

Dim(mm)LxDxH - Ebat (mm):	800x730x300
Plates - Isıtıcı Pleyt	: 4 x 3 kW
Power - Güç	: 12 kW
Gross Weight - Ağırlık	: 70 kg
Gross Volume - Hacim	: 0.41 m ³
Electrical Inlet - Elektrik Girişi	: 400V>3N PE
Price - Fiyat	: 1.616 €



KUSINA[®]

OTHER COOKING • DİĐER PİŐİRİCİ



Other Cooking / Salamanders • Salamender

GENERAL FEATURES

- Stainless steel body
- Infrared radiant heaters
- Height-adjustable heating element
- Pilot lamp
- Drip and oil collecting tray
- Easy to clean and hygienic
- 2 separate heater with individual control

GENEL ÖZELLİKLER

- Paslanmaz çelik gövde
- Kızılötesi radyant ısıtıcılar
- Yüksekliği ayarlanabilir boru tip ısıtıcılar
- Enerji regülötörü ve lambası
- Damlama ve yağ toplama tepsi
- Kolay temizlenebilir, hijyenik
- 2 ayrı ısıtıcı sayesinde ayrı kontrol

GPS200E ⚡

Dim(mm)LxDxH - Ebat (mm):	650X500X500
Power - Güç	: 3,5 KW
Gross Weight - Ağırlık	: 40 kg
Gross Volume - Hacim	: 0,47 m ³
Tray Dimensions - Tepsi boyutları	: 230 V 1N PE
Price - Fiyat	: 835 €



Other Cooking/Stone Oven • Taş Fırın

GENERAL FEATURES

- Special compact 1000x1000x70base stone
- Natural stone coated outer surface /Dome shaped top from fire bricks
- High isolation for heat loss
- Independent controlled high efficiently burners
- Manual mechanism to open the lid system
- Stainless steel tube legs
- Ergonomic design
- Easy to clean and hygienic

GENEL ÖZELLİKLER

- 1000x100x70 mm özel yekpare döküm taban taşı
- Doğal taş kaplama / Ateş Tuğlasından kubbe şeklinde
- Isı kaybına karşı yüksek izolasyon
- Birbirinden bağımsız kontrol edilebilen yüksek verimli brülörler
- 420 dereceye kadar iç sıcaklık / digital termometre
- Manuel mekanizma ile açılan kapak sistemi
- Paslanmaz boru ayaklar
- Ergonomik tasarım
- Kolay temizlenebilir, hijyenik

GRCTSFR20 🔥

Dim(mm)LxDxH - Ebat (mm):	1350x1350x1650
Power - Güç	: 20 kW
Gross Weight - Ağırlık	: 750 kg
Gross Volume - Hacim	: 3,15 m ³
Gas Inlet - Gaz Girişi	: R ½ "
Electrical Inlet - Elektrik Girişi	: 230 V 1N PE
Cooking Area- Pişirme Alanı	: 1000x1000 mm
Price - Fiyat	: 8.075 €



KUSINA®

CHARCOAL GRILL • KÖMÜRLÜ IZGARA



Charcoal Grill/Kömürlü Izgara



GENERAL FEATURES

- Electrostatic black powder coated or stainless steel heavy duty hygienic body with durable frame system.
- Stainless steel upper body and lifting columns.
- Adjustable grill platform with manual or optional motorized system
- Coal combustion chamber made from fire brick
- Ash scrapping hole in combustion chamber for easy ash collection.
- Cooking platform with removable grates for easy cleaning.
 - Round rod grate, square rod grate and cast iron grate options for various type of cooking
 - Removable stainless steel oil Havuz for easy cleaning.
 - Optional glass separation for prevent smell and smoke during cooking.
- Optional hood system with or w/o ventilation and filter system.

GENEL ÖZELLİKLER

- Dayanıklı çerçeve sistemi ile elektrostatik siyah toz veya paslanmaz çelik kaplı ağır işlere uygun hijyenik gövde
- Paslanmaz çelikten yapılmış üst gövde ve kaldırma tertibatları.
- Elektrikli kaldırma sistemi ile ayarlanabilir ızgara platformu
- Ateş tuğlası ile kaplanmış kömür yakma bölümü
- Kül toplama işlemini kolaylaştırmak için yanma bölümünde bulunan kül ayıklama yuvası
- Kolay temizlenmesi için çıkarılabilir ızgaraları olan pişirme platformu
 - Farklı gıda türleri için yuvarlak çubuklu ızgara, kare çubuklu ızgara ve dökme demir ızgara seçenekleri
 - Kolay temizleme için paslanmaz çelikten yapılmış çıkarılabilir yağ depoları
 - Pişirme sırasında koku ve dumanı engellemek için cam bölme seçeneği
- Havalandırma ve filtre sistemi bulunan veya bulunmayan kapak sistemi seçeneği

Charcoal Grill/Kömürlü Izgara

P-KM85HM12
P-KM85HM12E ⚡

Number of Grate - Izgara Sayısı	: 2
External Dimensions - Dış Ölçüler	: 1200x850x1784
Weight / Packed Weight -Ağırlık / Paketlenmiş Ağırlık	: 345 kg / 378 kg
Motor Energy - Motor Enerjisi	: 220 V / 240 V
Charocal Capacity per Cycle - Çevrim Başına Kömür Kapasitesi	: 22 kg
Manuel Control - Manuel kontrol	: 1/1
Coal Bin Trolleys (optional) - Kömür Kutusu Arabaları (isteğe bağlı)	: 1/1
Stainless Stell Body (optional) - Paslanmaz Çelik Gövde (isteğe bağlı)	: 1/1
Glass Seperators (optional) - Cam Ayırıcılar (isteğe bağlı)	: 1/1
Price - Fiyat	: 6.055 €



Charcoal Grill/Kömürlü Izgara

P-KM85HM16E ⚡

Number of Grate - Izgara Sayısı	: 3
External Dimensions - Dış Ölçüler	: 1600x850x1784
Weight / Packed Weight Ağırlık / Paketlenmiş Ağırlık	: 420 kg / 504 kg
Motor Energy - Motor Enerjisi	: 220 V / 240 V
Charcoal Capacity per Cycle - Çevrim Başına Kömür Kapasitesi	: 29 kg
Coal Bin Trolleys (optional) - Kömür Kutusu Arabaları (isteğe bağlı)	: 1/1
Stainless Steel Body (optional) - Paslanmaz Çelik Gövde (isteğe bağlı)	: 1/1
Glass Separators (optional) - Cam Ayırıcılar (isteğe bağlı)	: 1/1
Price - Fiyat	: 6.845 €



Charcoal Grill/Kömürlü Izgara

P-KM85HM20E ⚡

Number of Grate - Izgara Sayısı	: 4
External Dimensions - Dış Ölçüler	: 2000x850x1784
Weight / Packed Weight - Ağırlık / Paketlenmiş Ağırlık	: 550 kg / 630 kg
Motor Energy - Motor Enerjisi	: 220 V / 240 V
Charcoal Capacity per Cycle - Çevrim Başına Kömür Kapasitesi	: 37 kg
Coal Bin Trolleys (optional) - Kömür Kutusu Arabaları (isteğe bağlı)	: 1/1
Stainless Steel Body (optional) - Paslanmaz Çelik Gövde (isteğe bağlı)	: 1/1
Glass Separators (optional) - Cam Ayırıcılar (isteğe bağlı)	: 1/1
Price - Fiyat	: 7.900 €



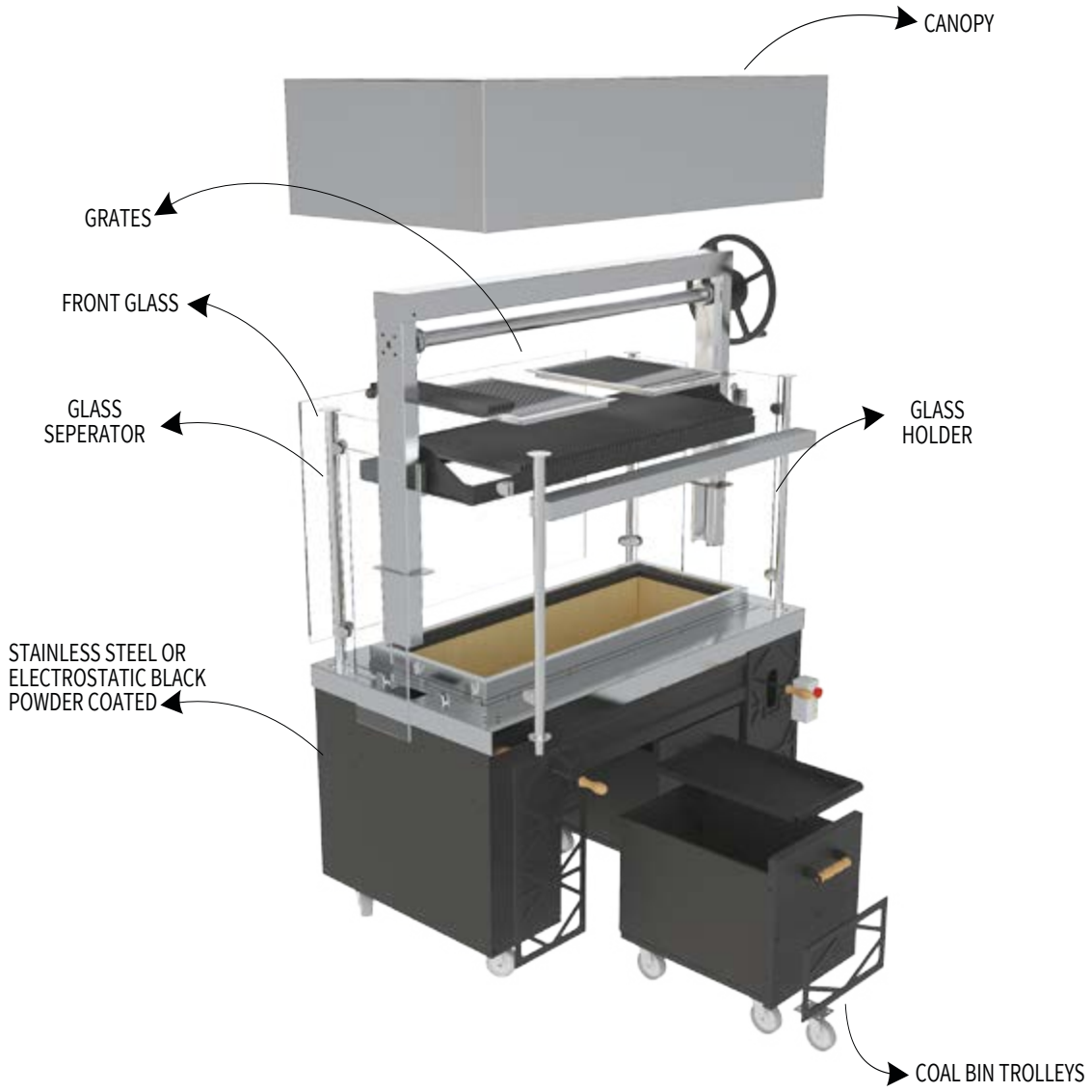

OPTIONAL			
CODE	NAME	FEATURES	PRICE
020.02.07.100	Front Glass for 1200 mm	1039x831x10 mm	89 €
020.02.07.101	Front Glass for 1600 mm	1439x83x10 mm	126 €
020.02.07.102	Front Glass for 2000 mm	1839x831x10 mm	158 €
020.02.07.103	Side Glass for All	270x831x10mm	24 €
085.405.0043	Canopy for 1200 mm	1200x850x400 mm	464 €
085.405.0044	Canopy for 1600 mm	1600x850x400 mm	540 €
085.405.0045	Canopy for 2000 mm	2000x850x400 mm	663 €
010.03.01.320	Glass Holder 850 mm	ø32 pipe	19 €
095.100.0025	Round Rod Grate	441x509 mm	302 €
095.100.0119	Square Rod Grate	441x509 mm	371 €
095.100.0024	Cast Iron Grate	600x185 mm	70 €
	Ship steering	ø 600	150 €

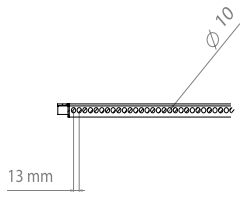

Round Rod Grate
095.100.0025

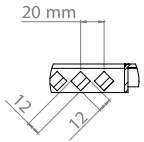
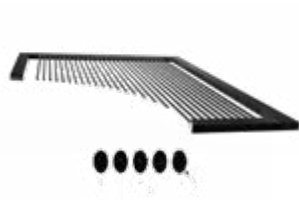

Square Rod Grate
095.100.0119

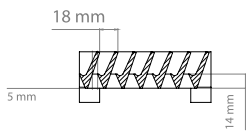

Cast Iron Grate
020.03.02.131



GRATE	CAST IRON GRATE	SQUARE ROD GRATE	ROUND ROD GRATE
Dimensions	600x185 mm	441x509 mm	441x509 mm
Rod Features	18 mm between grates	12x12 mm rod	ø10mm rod
Price	70 €	371 €	302 €

One Module Cooking Surface Dimensions

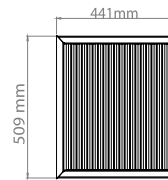

Two Module Cooking Surface Dimensions

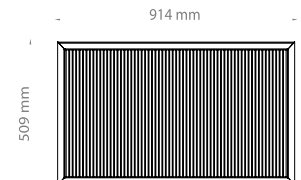

TOP VIEW

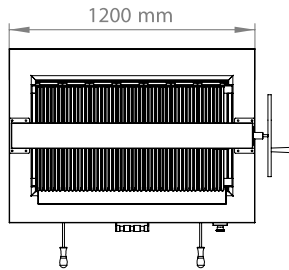

P-KM85HM12E

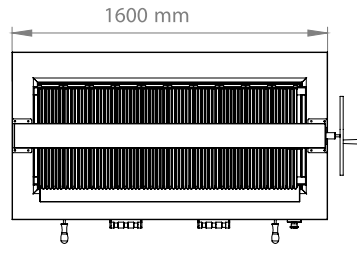

P-KM85HM16E

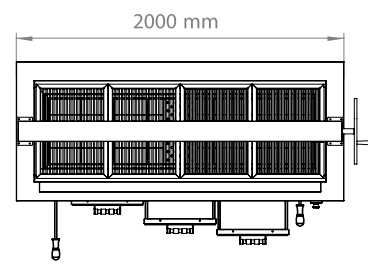

P-KM85HM20E

FRONT VIEW

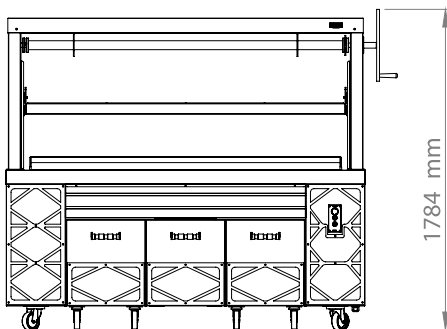

SIDE VIEW

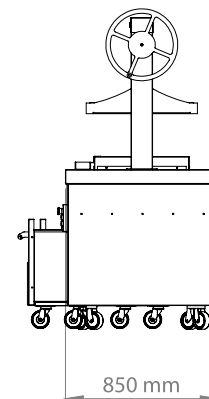

KUSINA®

BANQUET TROLLEYS • BANKET ARABALARI



Banquet Trolleys/Banquet Arabaları

Maximum Energy Efficiency

- Digital control with cabinet temperature display and setting.
- Fully compliant HACCP digital controls include visible alarms.
- Large storage area suitable to contain 2/1 GN containers or shelves on anti-tilt pressed runners.
- Cabinet fitted with up to 40 mm thickness of polyurethane insulation for best insulating performance with 100% environmental protection.
- Removable triple-chamber balloon magnetic gasket to improve insulation consumption.
- The heat can be monitored and adjusted between 50-90 °C with the thermometer.
- Removable bumpers the unit against damages.
- Two wheels with brakes and two without.
- Anti jamming design
- Well clean system with removable electric cabinet
- Heavy duty hinge mechanism
- Magnetic door lock
- 270 ° swing door

Maksimum Enerji Verim

- Dijital kontrol sistemi sayesinde kabin sıcaklıkları ayarlanabilir ve izlenebilir.
- HACCP ile tam uyumlu dijital kontrol sistemi ile uyarı ve ikazlar izlenebilir.
- Geniş depolama alanlı kabin pres baskılı devrilmeye karşı önlem alınmış kızaklar sayesinde GN 2/1 kütvetler yada raflar ile tam uyumludur.
- Kabini saran 40 mm kalınlığındaki polistiren dolgu çevreyi %100 koruma garantisi ile en iyi izolasyonu sağlar.
- İstenildiğinde kolayca yerinden çıkartılabilen kızaklı konveksiyon sistem ısıtma ünitesi.
- Cihazda kullanılan dijital termometre termostat ile 50-90 °C ısı aralığında kontrol edilebilir ve ısıyı gözlemlenebilir.
- Çarpmalara karşı darbe söndürücü plastik tamponlar.
- İki frenli , ikisi frensiz ø 150 mm tekerlekler.
- El sıkışmasını önleyici tasarım
- Sökülebilir elektrik paneli ile kolay temizlik
- Ağır sanayi tipi menteşeler
- Miknatıslı kilit sistemi
- 270 derece açılan kapılar



Hot Banquet Trolleys/Sıcak Banket Arabaları

GBA100H ⚡

Dim(mm)LxDxH - Ebat (mm): 810x930x1890 mm
Power - Güç : 2 kW
Gross Weight - Ağırlık : 176 kg
Gross Volume - Hacim : 1,83 m³
Cable Sections - Kablo Kesiti : 3x1,5 H 05 RRF
Electrical Inlet - Elektrik Girişi : 230 V 1N PE
Tray Capacity - Tepsi Kapasitesi: 18 Pcs GN 2/1x65 - 36 Pcs GN 1/1x65
Price - Fiyat : 2.117 €



Hot Banquet Trolleys/Sıcak Banket Arabaları

GBA200H ⚡

Dim(mm)LxDxH - Ebat (mm): 1500x930x1890 mm
Power - Güç : 2 kW
Gross Weight - Ağırlık : 295 kg
Gross Volume - Hacim : 2,68 m³
Cable Sections - Kablo Kesiti : 3x1,5 H 05 RRF
Electrical Inlet - Elektrik Girişi : 230 V 1N PE
Tray Capacity - Tepsi Kapasitesi: 36 Pcs GN 2/1x65 - 72 Pcs GN 1/1x65
Price - Fiyat : 3.770 €



Hot Banquet Trolleys/Sıcak Banket Arabaları

GBA110H

Dim(mm)LxDxH - Ebat (mm)	: 810x930x1660 mm
Power - Güç	: 2 kW
Gross Weight - Ağırlık	: 157 kg
Gross Volume - Hacim	: 1,70 m ³
Cable Sections - Kablo Kesiti	: 3x1,5 H 05 RRF
Electrical Inlet - Elektrik Girişi	: 230 V 1N PE
Tray Capacity - Tepsi Kapasitesi	: 15 Pcs GN 2x1 65 - 30 Pcs GN 1/1 Gn
Price - Fiyat	: 1.991 €



Hot Banquet Trolleys/Sıcak Banket Arabaları

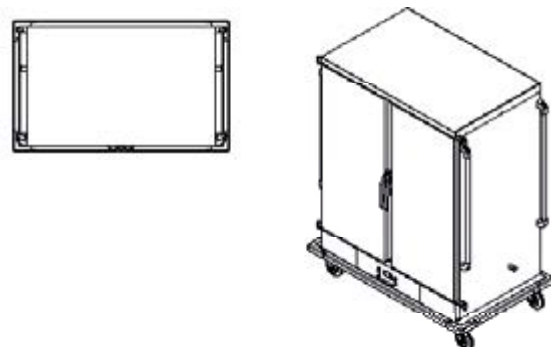
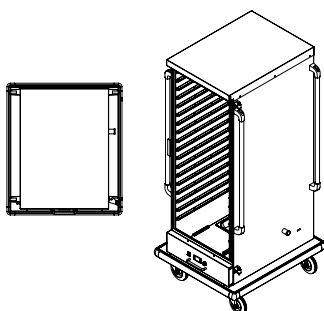
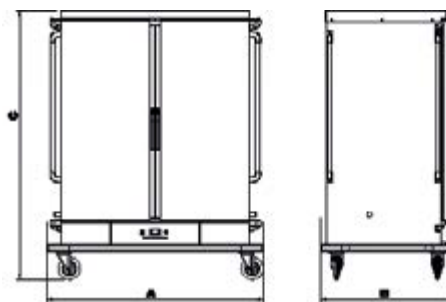
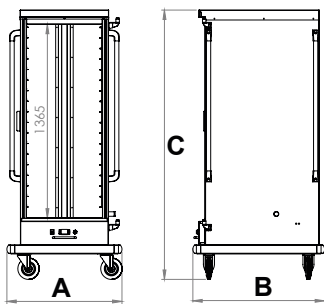
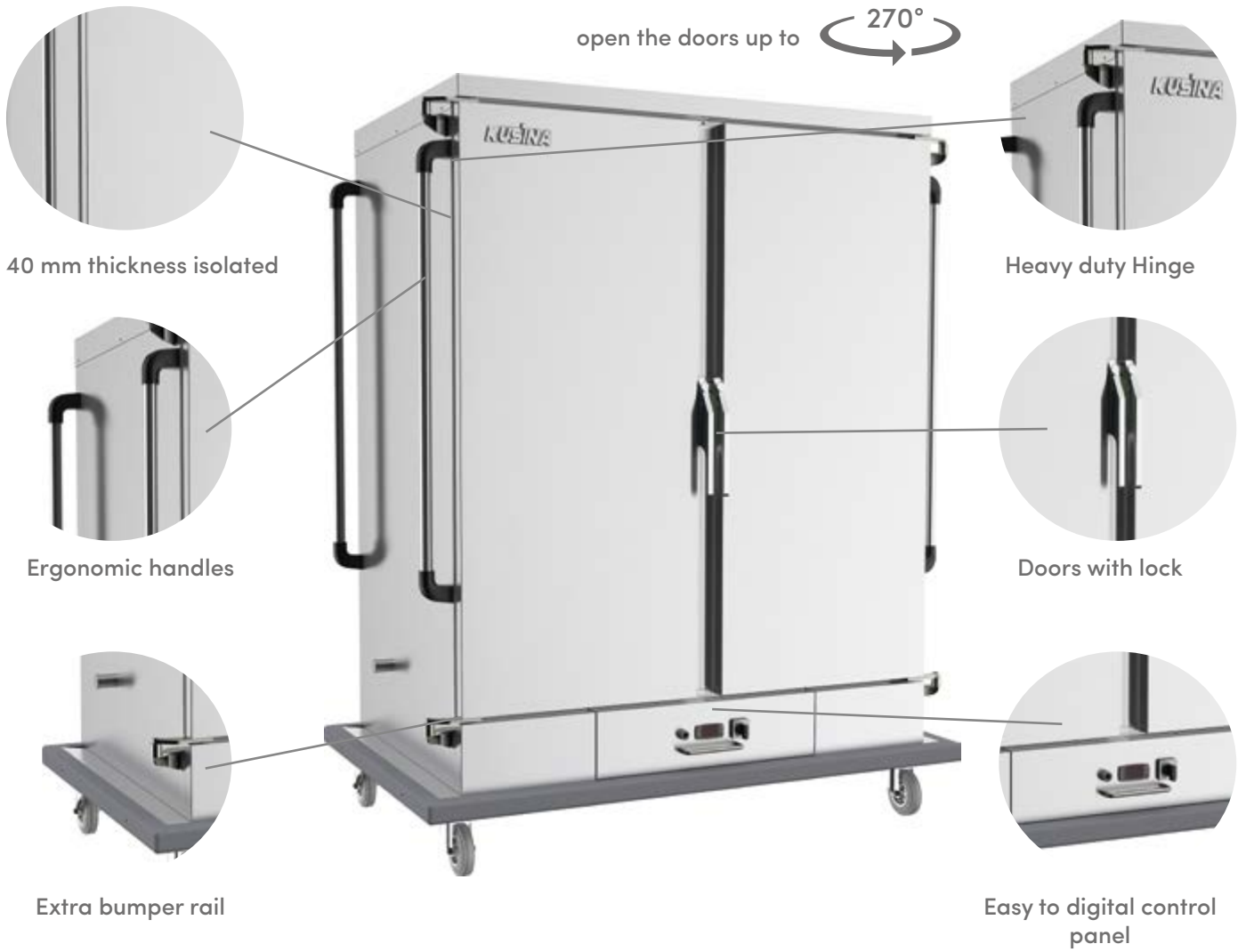

KUSINA®

FOOD SERVERY COUNTERS • YEMEK SERVİS HATLARI





GENERAL FEATURES

- Decorative ve arranged and ready for serving
- Mobile modules provide to easy to use
- The Kusina hot food counters allow you to put warmid shes perfectly in the limelight.
- Especially for the serving business and meal counters the cold food counters are the first choice.
- Thanks to the warm-keeping funct on with simultaneous air humidificat on the meals stay juicy and precisely tempered.
- The height-adjustable support grate offer you full variability in using the interior space.
- Available in a flat glass design or rounded panoramic compartment with different sizes and front glass and roller blinds.
- In addition to that, all showcases are equipped with su table lighting and offer space for presenting the products effectively on two or three levels.

GENEL ÖZELLİKLER

- Dekoratif olarak düzenlenmiş ve servis için hazır.
- Mobil modüller sayesinde kullanımı kolaylığı sağlar.
- Kusina servis hatları, sıcak ve soğuk yemekleri mükemmel bir şekilde koymanıza izin verir.
- Özellikle soğuk yiyecek servis veren işletme ve yemek işletmeleri için ilk tercihtir.
- Eşzamanlı hava nemlendirmeli ısınma fonksiyonu sayesinde yemekler sulu ve tam olarak temperlenir.
- Yüksekliği ayarlanabilir destek ızgarası, iç mekan kullanımında size tam değişkenlik sunar.
- Düz cam tasarımlı veya farklı boyutlarda ve ön cam ve jaluzili seçenekleri ile yuvarlatılmış panoramik bölmeler mevcuttur. Buna ek olarak, tüm vitrinler uygun aydınlatma ile donatılmıştır ve ürünleri iki veya üç düzeyde etkili bir şekilde sunma imkanı sunar.

Hot,Cold & Nutr food counters/Sıcak, Soğuk ve Nötr Gıda Servis Hatları

REFRIGERATED DISPLAY

PRODUCT SPECIFICATIONS

Moduler Fronts: The module fronts can be designed according to your requirements. Available in Resopal in all colours, wood veneer, natural stone or stainless steel.

Tray slides: The fold-down tray slides can be made of stainless-steel round tube or synthetic-coated plywood.

Variable Top Surfaces: All work areas are made of hygienic stainless steel as standard. But elegant granite of differing varieties is also possible – take your pick!

Mobile Or Fixed: All modules except for the corner modules come with 4 steering castors (2 of which have brakes) as standard. Instead of castors, they can also be delivered with feet and a skirting panel.

Temperature control with digital display
Integrated cooling tray for max. 3x or 4x GN-1/1-150
With 1 or 2 cooled compartments for four GN-1/1 containers each

This refrigerated displays should only be used in environments where ambient air does not exceed 25 degrees centigrade or 55-percent relative humidity.

SOĞUK VİTRİN ÜRÜN DETAYLARI

Modüllerin önleri: ihtiyaçlarınıza göre tasarlanabilir. Renk Kartelasın' da tüm renklerde, ahşap kaplama, doğal taş veya paslanmaz çelik olarak mevcuttur.

Tepsi kızakları: Katlanabilir tepsi kızakları, paslanmaz çelik yuvarlak borudan veya sentetik kaplamalı kontrplaktan yapılabilir. Değişken Üst yüzey: Tüm çalışma alanları standart olarak hijyenik paslanmaz çelikten imal edilmiştir. Ancak farklı çeşitlerden oluşan zarif granit de mümkündür.

Mobil veya sabit: Köşe modülleri dışındaki tüm modüller standart olarak 4 tekerleği (2 tanesi frenli) ile birlikte gelir. Tekerlekler yerine, ayakları ve bir süpürgelik paneli ile de teslim edilebilirler.

Dijital göstergeli sıcaklık kontrolü
Maks. 3x veya 4x GN-1 / 1-150
Her biri dört GN-1/1 konteyner için 1 veya 2 soğutmalı bölme ile

Bu soğutmalı dolaplar, yalnızca ortam havasının 25 santigrat derecesi ve yüzde 55 bağıl nemi geçmediği ortamlarda kullanılmalıdır.



Nova Cold Display Unit/Nova Dik Teşhir Soğuk Buzdolabı

N-DT70BS12

Nova Cold Display Unit/Nova Dik Teşhir Soğuk Buzdolabı

- Size W: 1200 D : 700 H: 850 / 1650 mm
- Automatic defrost - Otomatik defrost
- Display Capacity- Vitrin Kapasitesi: 400 lt
- Power- Güç : 1 kW / 230 V 50 Hz
- Lower Refrigerator Cabinet - Alt Soğutucu Dolap: 30 lt
- Gross Volume - Hacim : 2 m³.
- Capacity of cooling tray: 3 x GN 1/1, max. depth: 100 mm
- Soğutma havuzu kapasitesi: 3 x GN 1/1, maks. derinlik: 100 mm
- Price - Fiyat : 4.284 €



N-DT70BS15

Nova Cold Display Unit/Nova Dik Teşhir Soğuk Buzdolabı

- Size W: 1500 D : 700 H: 850 / 1650 mm
- Automatic defrost - Otomatik defrost
- Display Capacity- Vitrin Kapasitesi: 500 lt
- Power- Güç : 1 kW / 230 V 50 Hz
- Lower Refrigerator Cabinet - Alt Soğutucu Dolap: 35 lt
- Gross Volume - Hacim : 2,5 m³.
- Capacity of cooling tray: 4 x GN 1/1, max. depth: 100 mm
- Soğutma havuzu kapasitesi: 4 x GN 1/1, maks. derinlik: 100mm
- Price - Fiyat : 4.302 €



Nova Cold Display Unit/Nova Dik Teşhir Soğuk Buzdolabı

N-DT70BS19

Nova Cold Display Unit/Nova Dik Teşhir Soğuk Buzdolabı

- Size W: 1900 D : 700 H: 850 / 1650 mm
- Automatic defrost - Otomatik defrost
- Display Capacity- Vitrin Kapasitesi: 650 lt
- Power- Güç : 1 kW / 230 V 50 Hz
- Lower Refrigerator Cabinet - Alt Soğutucu
- Dolap: 28 lt
- Gross Volume - Hacim : 2,5 m³.
- Capacity of cooling tray: 5 x GN 1/1, max. depth: 100 mm
- Soğutma havuzu kapasitesi: 5 x GN 1/1, maks. derinlik 100 mm
- Price - Fiyat : 4.824 €



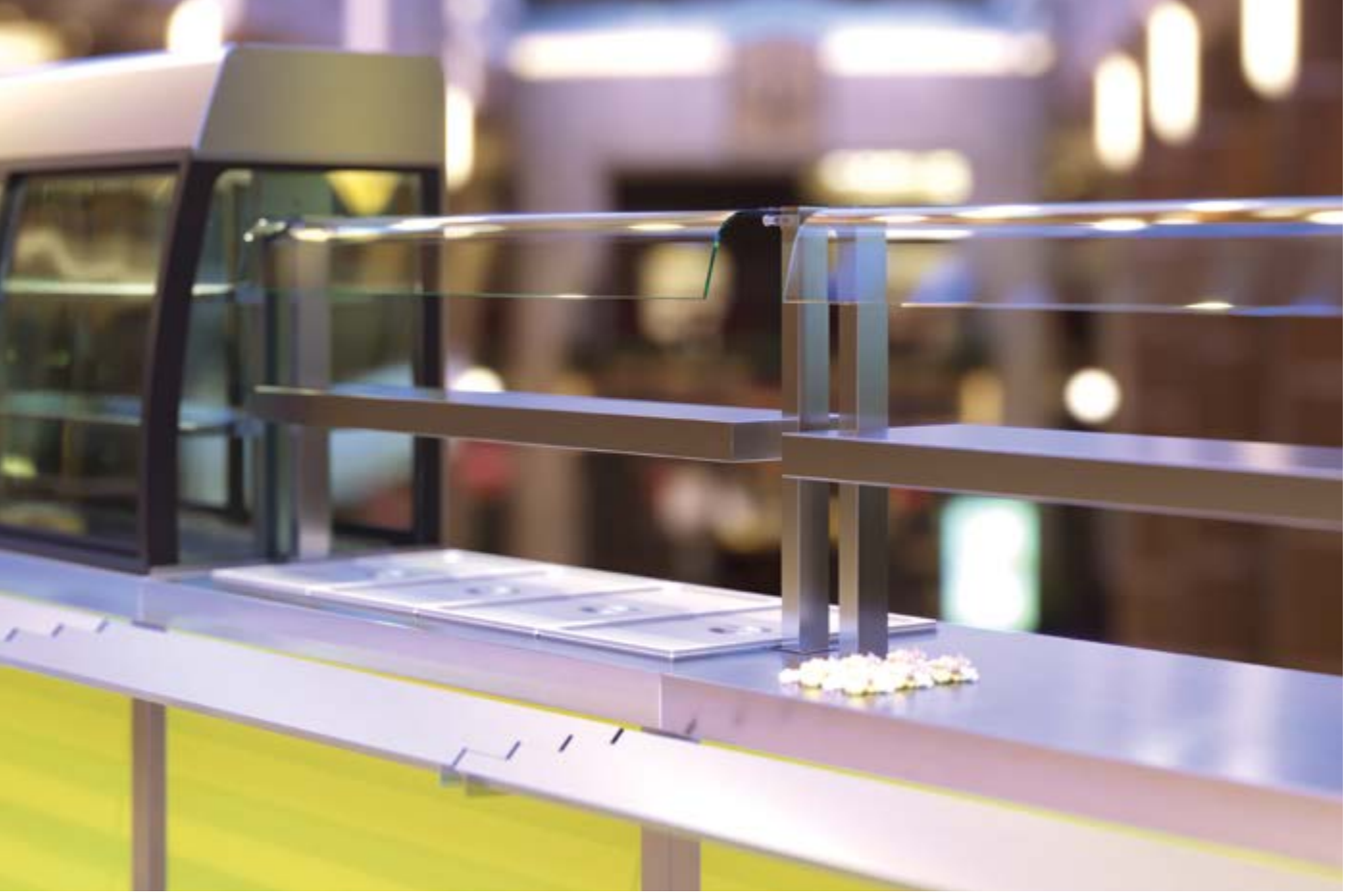

HOT FOOD COUNTERS

Decorative arranged and ready for serving:

- Designed for display of warm food
- Made in stainless steel
- Interior led lighting
- Humidity control, thanks to water drawer to prevent the drying out of exposed products
- For GN 1/1 trays with maximum depth of 150 mm.
- Digital display showing the temperature
- Keeps the initial temperature (70°C / 80°C) of exposed products max. 2 hours with 5 °C difference
- Heating performance between 60°C -90°C at 23 °C and % 55 humidity condition
- Easy water drain with included bottom surface

SICAK YEMEK SERVİS HATTI

Dekoratif olarak düzenlenmiş ve servis için hazır:

- Sıcak yiyeceklerin sunumu için tasarlanmıştır.
- Paslanmaz çelikten imal edilmiştir.
- Led ile aydınlatılır.
- Nemlendirme yöntemi ile sunulan yiyeceklerin kuruması önlenir.
- Max. 150 mm. yükseklik ile GN 1/1'e uygundur.
- Dijital sıcaklık göstergesi vardır.
- 70°C / 80°C başlangıç sıcaklığındaki yiyecekleri 2 saat boyunca 5 °C farkla koruyabilir.
- 23 °C ve % 55 nemli ortamda , yiyeceklerin ısısını 60 °C - 90 °C ye çıkabilir.
- Zemin tablasındaki eğim ile suyun kolay tahliyesi sağlanır.

Nova Hot Display Unit/Nova Dik Teşhir Sıcak Teşhir

N-DT70SS12

Nova Hot Display Unit/Nova Dik Teşhir Sıcak Servis

- Size - Boyut W: 1200 D : 700 H: 850 / 1650 mm
- Display Capacity- Vitrin Kapasitesi: 400 lt
- Power- Güç : 1 kW / 230 V 50 Hz
- Lower Refrigerator Cabinet - Alt Dolap Kapasite : 30 lt
- Gross Volume - Hacim :1,2 m³
- Capacity of hot basin : 3 x GN 1/1, max. depth: 150 mm
- Sıcak havuz kapasitesi: 3 x GN 1/1, maks. derinlik: 150 mm
- Price - Fiyat : 2.786 €



N-DT70SS15

Nova Hot Display Unit/Nova Dik Teşhir Sıcak Servis

- Size - Boyut W: 1500 D : 700 H: 850 / 1650 mm
- Display Capacity- Vitrin Kapasitesi: 500 lt
- Power- Güç : 1 kW / 230 V 50 Hz
- Lower Refrigerator Cabinet - Alt Dolap Kapasite : 35 litre
- Gross Volume - Hacim : 1,4 m³
- Capacity of hot basin tray: 4 x GN 1/1, max. depth: 100 mm
- Sıcak havuz kapasitesi: 4 x GN 1/1, maks. derinlik: 100 mm
- Price - Fiyat : 3.614 €



Optional / Nova Hot Display Warming Cupboard Unit
Opsiyonel / Nova Sıcak Teşhir Servis Sıcaklık Ünitesi





BAIN MARIE UNIT

- Open storage area on operator side, stainless doors as optional
- Stainless steel tray scroll
- 1 warm lighted service shelf.
- The thermostatic controlled temperature can be set between +20 and + 90 ° C in accordance with HACCP regulations.
- Electronic protection against overheating.
- The stainless steel base can be mounted to close the feet.
- Manual water filling is standard; automatic valve water filling is available as an option.
- Digital control panel.
- It is easy to clean the pool with drain tap and rounded corner.

BENMARI ÜNİTESİ

- Operatör tarafında açık depolama alanı, opsiyonel olarak paslanmaz kapılar
- Paslanmaz çelik tepsi kaydırma
- 1 adet sıcak ışıklı servis rafı.
- Termostatik kontrollü sıcaklık, HACCP yönetmeliklerine uygun olarak +20 ile +90°C arasında ayarlanabilir.
- Aşırı ısınmaya karşı elektronik koruma.
- Paslanmaz baza tekmelikler ayakları kapamak için monte edilebilir.
- Manuel su doldurma standarttır; otomatik valfli su doldurma opsiyonel olarak mevcuttur.
- Dijital kontrol paneli.
- Drenaj musluklu ve yuvarlatılmış köşeli havuzun temizliği çok kolaydır.

N-B70SSU12

Nova Bainmarie Hot Service/Nova Benmari Sıcak Servis Ünitesi

- Size - Boyut W: 1200 D: 700 H: 850 / 1650 mm
- GN Capacity- Gn Kapasitesi: 3 x GN 1/1 150 mm max depht
- Power- Güç : 3 kW / 230 V 50 Hz
- Open bottom Cabinet Capacity - Açık Alt Dolap Kapasite : 80 lt
- Gross Volume - Hacim: 1,3 m³
- GN containers are included- Gn Kaplar dahildir.
- Price - Fiyat : 1.722 €



N-B70SSU15

Nova Bainmarie Hot Service/Nova Benmari Sıcak Servis Ünitesi

- Size - Boyut W: 1500 D: 700 H: 850 / 1650 mm
- GN Capacity- Gn Kapasitesi: 4 x GN 1/1 150 mm max depht
- Power- Güç : 3,2 kW / 230 V 50 Hz
- Open bottom Cabinet Capacity - Açık Alt Dolap Kapasite : 100 lt
- Gross Volume - Hacim : 1,5 m³
- GN containers are included- Gn Kaplar dahildir.
- Price - Fiyat : 1.885 €



Nova Bain Marie Hot Service/Nova Benmari Sıcak Servis Ünitesi

N-B70SSU19

Nova Bainmarie Hot Service/Nova Benmari Sıcak Servis Ünitesi

- Size - Boyut : W: 1900 D: 700 H: 850 / 1650 mm
- GN Capacity- Gn Kapasitesi: 5 x GN 1/1 150 mm max depht
- Electrical Inlet- Elektrik Girişi: 4,5 kW / 230 V N PE
- Gross Volume : 1,52 m³
- Open bottom Cabinet Capacity - Açık Alt Dolap Kapasite: 120 lt
- GN containers are included- Gn Kaplar dahildir.
- Price - Fiyat: 2.210 €



N-B70SSU24

Nova Bainmarie Hot Service/Nova Benmari Sıcak Servis Ünitesi

- Size - Boyut : W: 2400 D: 700 H: 850
- GN Capacity- Gn Kapasitesi: 6 x GN 1/1 150 mm max depht
- Electrical Inlet- Elektrik Girişi: 5,8 kW / 230 V N PE
- Gross Volume: 1,9 m³
- Open bottom Cabinet Capacity - Açık Alt Dolap Kapasite : 160 lt
- GN containers are included- Gn Kaplar dahildir.
- Price - Fiyat : 2.504 €



Self Service Warming Cupboard/Nova Sıcaklık Dolabı

N-B70BSD12

Self Service Warming Cupboard/Nova Sıcaklık Dolabı

- Size - Boyut W: 1200 D : 700 H: 850 / 1650 mm
- Open Upper Cabinet Capacity - Açık Alt Dolap Kapasite : 80 lt
- GN Capacity- Gn Kapasitesi: 3 x GN 1/1 150 mm max depht
- Electrical Inlet- Elektrik Girişi : 1 kW / 230 V N PE
- Gross Volume : 0,98m³
- Price - Fiyat : 1.928 €



N-B70BSD15

Self Service Warming Cupboard/Nova Sıcaklık Dolabı

- Size - Boyut W: 1500 D : 700 H: 850 / 1650 mm
- Open Upper Cabinet Capacity - Açık Alt Dolap Kapasite : 100 lt
- GN Capacity- Gn Kapasitesi: 4 x GN 1/1 150 mm max depht
- Electrical Inlet- Elektrik Girişi : 1 kW / 230 V N PE
- Gross Volume : 1,2 m³
- Price - Fiyat : 2.110 €



Self Service Warming Cupboard/Nova Sıcaklık Dolabı

Self Service Warming Cupboard/Nova Sıcaklık Dolabı

N-B70BSD19

- Size - Boyut W: 1900 D : 700 H: 850 / 1650 mm
- Open Upper Cabinet Capacity - Açık Alt Dolap Kapasite : 140 lt
- GN Capacity- Gn Kapasitesi: 5 x GN 1/1 150 mm max depht
- Electrical Inlet- Elektrik Girişi : 1 kW / 230 V N PE
- Gross Volume : 1,52 m³
- Price - Fiyat : 2.453 €



Self Service Warming Cupboard/Nova Sıcaklık Dolabı

N-B70BSD22

- Size - Boyut W: 2200 D : 700 H: 850 / 1650 mm
- Open Upper Cabinet Capacity - Açık Alt Dolap Kapasite : 160 lt
- GN Capacity- Gn Kapasitesi: 6 x GN 1/1 150 mm max depht
- Electrical Inlet- Elektrik Girişi : 1 kW / 230 V N PE
- Gross Volume : 1,75 m³
- Price - Fiyat : 2.821 €



Nova Serving Unit With Sliding Door/Nova Sürgü Kapaklı Servis Ünitesi

N-NS70NT14

Nova Serving Unit With Sliding Door/Nova Sürgü Kapaklı Servis Ünitesi

- Size - Boyut W: 1400 D : 700 H: 850 / 1650 mm
- Tray size- Tepsi Ölçüsü : 300/450 mm
- Lower Cabinet Capacity - Alt Dolap Kapasite : 65 lt
- Price - Fiyat : 946 €



N-NS70NT16

Nova Serving Unit With Sliding Door/Nova Sürgü Kapaklı Servis Ünitesi

- Size - Boyut W: 1600 D : 700 H: 850 / 1650 mm
- Tray size- Tepsi Ölçüsü : 300/450 mm
- Lower Cabinet Capacity - Açık Alt Dolap Kapasite : 45 lt
- Gross Volume - Hacim :1,8 m³
- Price - Fiyat : 1.012 €



Nova Cashier's Unit/Nova Kasa Servis Ünitesi

Nova Cashier's Unit/Nova Kasa Servis Ünitesi

N-KS70NT14	Price - Fiyat : 1.140 €	1400X700X850 mm
N-KS70NT16	Price - Fiyat : 1.252 €	1600X700X850 mm
N-KS70NT18	Price - Fiyat : 1.352 €	1800X700X850 mm
N-KS70NT20	Price - Fiyat : 1.455 €	2000X700X850 mm



Nova Couvert Unit/Nova Küver Ünitesi

N-K70KBE70

Nova Couvert Unit/Nova Küver Ünitesi

- Size - Boyut W: 700 D : 700 H: 850 / 1650 mm
- Bottom Gn size - Alt Gn ölçüsü : GN 1/1 150 mm max
- Thumbler rack capacity- Bardak rafı kapasitesi: Ø35 x35 Pcs
- Top spoon fork rack-üst çatal kaşık rafı : GN 1/4 x4 Pcs
- GN containers are included- Gn Kaplar dahildir.
- Price - Fiyat : 634 €



Nova Couvert Unit/Nova Küver Ünitesi

N-K70KBE10

Nova Couvert Unit/Nova Küver Ünitesi

- Size - Boyut W: 1000 D : 700 H: 850 / 1650 mm
- Bottom Gn size - Alt Gn ölçüsü : GN 1/1 150 mm max
- Thumbler rack capacity- Bardak rafı kapasitesi: Ø35 x35 Pcs
- Top spoon fork rack-Üstr çatal kaşık rafı : GN 1/4 x4 Pcs
- Gross Volume - Hacim :1,54 m³
- GN containers are included- Gn Kaplar dahildir.
- Price - Fiyat : 1.130 €



N-K70KBE14

Nova Couvert Unit/Nova Küver Ünitesi

- Size - Boyut W: 1400 D : 700 H: 850 / 1650 mm
- Bottom Tray Capacity -Alt Tepsi Kapasitesi: 370x530 mm-200 Pcs max.
- Thumbler rack capacity- Bardak rafı kapasitesi: Ø35 x35 Pcs
- Top spoon fork rack-Üstr çatal kaşık rafı : GN 1/4 x4 Pcs
- Gross Volume - Hacim :1,75 m³
- GN containers are included- Gn Kaplar dahildir.
- Price - Fiyat : 1.623 €



Nova dish serving unit/Nova tabak servis ünitesi

N-TS70DT50E

Nova Dishing Serving Unit/Nova Tabak Servis Ünitesi

- Size - Boyut W: 500 D : 700 H: 850mm
- Plate Capacity- Tabak Kapasitesi: Ø28 or Ø32x 50 Pcs
- Power- Güç : 0,75 kW / 230 V 50 Hz
- Gross Volume - Hacim : 1,8 m³
- Price - Fiyat : 975 €



N-UT70DK15

External Corner Service Unit/Dış Köşe Uyum Servis Ünitesi

- Size - Boyut W : 1500 x 700 x 850
- Gross Volume - Hacim : 2,13 m³
- Price - Fiyat : 628 €



N-UT70IK15

Inner Corner Service Unit/İç Köşe Uyum Servis Ünitesi

- Size - Boyut W: 1500 x 700 x 850
- Gross Volume - Hacim : 1,74 m³
- Price - Fiyat : 690 €



Flat Color Options/Düz Renk Seçenekleri

** Before order, please ask stock with color code !!

					
D102 BEJ	D104 FİLDİŞİ	D107 SİYAH	D108 MAVİ	D109 LACİVERT	D114 TURUNCU
					
D116 METALİK GRİ	D117 KIRMIZI	D118 ELVİRA	D120 PEMBE	D122 VİZON	D123 AÇIK GRİ
					
D125 ŞEKER PEMBE	D126 CAPUCCINO	D128 CAFE MOKA	D129 LAKE BEYAZ	D133 KOYU SARI	D134 PASTEL YEŞİL
					
D135 VERDE	D137 MENEKŞE	D138 LİLA	D140 KUM TAŞI	D141 KÜL GRİ	D142 GRANİT
					
D143 ANTRASİT	D145 BRONZ	D149 MERLO	D152 OPAK BEYAZ	D153 BAKIR	D158 KAHVE GALAXY
					
D159 KAREMEL GALAXY	D160 AYTAŞI	D161 DAFNE	D162 SEDEF	D163 MERCAN	D164 LUNA
					
D166 KUBA	D167 ROSE	D168 BERRY			

Sipariş öncesi renk stok durumunu satıcınıza sorunuz.

Wooden Color Options/Ahşap Renk Seçenekleri

** Before order, please ask stock with color code !!



Sipariş öncesi renk stok durumunu satıcınıza sorunuz.



GENERAL FEATURES

- Decorative ve arranged and ready for serving
- Mobile modules provide to easy to use
- The Kusina hot food counters allow you to put warmid shes perfectly in the limelight.
- Especially for the serving business and meal counters the cold food counters are the first choice.
- Thanks to the warm-keeping function with simultaneous air humidification the meals stay juicy and precisely tempered.
- The height-adjustable support grate offer you full variability in using the interior space.
- Available in a flat glass design or rounded panoramic compartment with different sizes and front glass and roller blinds.
- In addition to that, all showcases are equipped with suitable lighting and offer space for presenting the products effectively on two or three levels.

GENEL ÖZELLİKLER

- Dekoratif olarak düzenlenmiş ve servis için hazır.
 - Mobil modüller sayesinde kullanımı kolaylığı sağlar.
 - Kusina servis hatları, sıcak ve soğuk yemekleri mükemmel bir şekilde koymanıza izin verir
 - Özellikle soğuk yiyecek servis veren işletme ve yemek işletmeleri için ilk tercihtir
 - Eş zamanlı hava nemlendirmeli sıcak tutma işlevi sayesinde yemekler sulu ve hassas bir şekilde tavllanmış halde kalır.
 - Yüksekliği ayarlanabilir destek ızgarası, iç mekan kullanımında size tam değişkenlik sunar.
 - Düz cam tasarımlı veya farklı boyutlarda ve ön cam ve jaluzili seçenekler ile yuvarlatılmış panoramik bölmeler mevcuttur.
- Buna ek olarak, tüm vitrinler uygun aydınlatma ile donatılmıştır ve ürünler iki veya üç düzeyde etkili bir şekilde sunma imkanı sunar.

Hot, Cold & Noth Food Counters/Sıcak, Soğuk ve Nötr Gıda Servis Hatları

REFRIGERATED DISPLAY

PRODUCT SPECIFICATIONS

Moduler Fronts: The module fronts can be designed according to your requirements. Available in Resopal in all colours, wood veneer, natural stone or stainless steel.

Tray slides: The fold-down tray slides can be made of stainless-steel round tube or synthetic-coated plywood.

Variable Top Surfaces: All work areas are made of hygienic stainless steel as standard. But elegant granite of differing varieties is also possible – take your pick !

Mobile Or Fixed: All modules except for the corner modules come with 4 steering castors (2 of which have brakes) as standard. Instead of castors, they can also be delivered with feet and a skirting panel.

Temperature control with digital display

Integrated cooling tray for max. 3x or 4x GN-1/1-150

With 1 or 2 cooled compartments for four GN-1/1 containers each

SOĞUK VİTRİN

ÜRÜN DETAYLARI

Modüllerin önleri: İhtiyaçlarınıza göre tasarlanabilir. Renk Kartelasın' da tüm renklerde, ahşap kaplama, doğal taş veya paslanmaz çelik olarak mevcuttur.

Tepsi kızakları: Katlanabilir tepsi kızakları, paslanmaz çelik yuvarlak borudan veya sentetik kaplamalı kontrplaktan yapılabilir.

Değişken Üst yüzey: Tüm çalışma alanları standart olarak hijyenik paslanmaz çelikten mal edilmiştir. Ancak farklı çeşitlerden oluşan zarif granit de mümkündür.

Mobil veya sabit: Köşe modüller dışındaki tüm modüller standart olarak 4 tekerlek (2 tanes frenli) ile birlikte gelir. Tekerlekler yerine, ayakları ve bir süpürgelik panel ile de teslim edilebilirler.

Dijital göstergel sıcaklık kontrolü

Maks. 3x veya 4x GN-1 / 1-150

Her bir dört GN-1/1 konteyner için 1 veya 2 soğutmalı bölme ile



Classic Cold Display Unit/Classic Dik Teşhir Soğuk Buzdolabı

K-KT70ST13

Classic Cold Display Unit/Classic Dik Teşhir Soğuk Buzdolabı

- Size - Boyut W:1300 D: 700 H: 850/1850 mm
- Automatic defrost - Otomatik defrost
- Display Capacity- Vitrin Kapasitesi: 440 lt
- Power-Güç: 1 kW/230V50Hz
- Lower Refrigerator Cabinet - Alt Soğutucu Dolap: 164 lt
- Gross Volume - Hacim: 2,04 m³
- Cooling Well / Soğutma havuzu: 3 x GN 1/1, maks. derinlik: 100 mm
- Double Side Sliding Doors-Çift taraflı kayar kapılar
- Temperature range: 2 °C to + 8 °C
- Price - Fiyat : 3.640 €



K-KT70ST15

Classic Cold Display Unit/Classic Dik Teşhir Soğuk Buzdolabı

- Size - Boyut W: 1500 D: 700 H: 850/1850 mm
- Automatic defrost - Otomatik defrost
- Display Capacity- Vitrin Kapasitesi: 580 lt
- Power- Güç: 1 kW/230 V 50 Hz
- Lower Refrigerator Cabinet - Alt Soğutucu Dolap: 244 lt
- Gross Volume - Hacim: 2,04 m³
- Cooling Well / Soğutma havuzu: 3 x GN 1/1, maks. derinlik: 100 mm
- Double Side Sliding Doors - Çift taraflı kayar kapılar
- Temperature range: 2 °C to + 8 °C
- Price - Fiyat : 3.772 €



Classic Cold Display Unit/Classic Dik Teşhir Soğuk Buzdolabı

K-KT70ST18

Classic Cold Display Unit/Classic Dik Teşhir Soğuk Buzdolabı

- Size - Boyut W: 1800 D: 700 H: 850 / 1850 mm
- Automatic defrost - Otomatik defrost
- Display Capacity- Vitrin Kapasitesi: 680 lt
- Power- Güç: 1 kW/ 230 V 50 Hz
- Lower Refrigerator Cabinet - Alt Soğutucu Dolap: 250 lt
- Gross Volume - Hacim: 2,04 m³.
- Cooling Well / Soğutma havuzu: 3 x GN 1/1, maks. derinlik: 100 mm
- Double Side Sliding Doors-Çift taraflı kayar kapılar
- Temperature range: 2 °C to + 8 °C
- Price - Fiyat : 3.969 €



Service unit with cold well/Self Servis Soğuk Havuz Soğutmalı

K-T70DH12E

Service Unit With Cold Well/Self Servis Soğuk Havuz Soğutmalı

- Size - Boyut W: 1200 D : 700 H: 850 mm.
- Automatic defrost - Otomatik defrost
- Power- Güç : 1 kW / 230 V 50 Hz
- Gross Volume - Hacim :0,98 m³
- Cooling Well / Soğutma havuzu : 3 x GN 1/1 maks. De. : 100 mm
- Temperature range: 2 °C to + 8 °C
- Gn containers are not included- Gn kaplar dahil değildir.
- Price - Fiyat : 2.070 €



K-T70DH16E

Service Unit With Cold Well/Self Servis Soğuk Havuz Soğutmalı

- Size - Boyut W: 1600 D: 700 H: 850 mm.
- Automatic defrost - Otomatik defrost
- Power- Güç: 1 kW / 230 V 50 Hz
- Gross Volume - Hacim: 1,86 m³.
- Cooling Well / Soğutma havuzu: 4 x GN 1/1, maks. De. : 100 mm
- Temperature range: 2 °C to + 8 °C
- Gn containers are not included- Gn kaplar dahil değildir.
- Price - Fiyat : 2.195 €



K-T70DH18E

Service Unit With Cold Well/Self Servis Soğuk Havuz Soğutmalı

- Size - Boyut W: 1800 D : 700 H: 850 mm.
- Automatic defrost - Otomatik defrost
- Power- Güç: 1 kW / 230 V 50 Hz
- Gross Volume - Hacim: 2,04 m³.
- Cooling Well / Soğutma havuzu: 5 x GN 1/1, maks. De. : 100 mm
- Temperature range: 2 °C to + 8 °C
- Gn containers are not included- Gn kaplar dahil değildir.
- Price - Fiyat : 2.439 €



Self Service Refrigerator With Cold Well/Self Servis Buzdolabı

K-ST70BZ14

Self Service Refrigerator With Cold Well/ Self Servis Buzdolabı

- Size - Boyut W: 1400 D : 700 H: 850 mm.
- Automatic defrost - Otomatik defrost
- Power- Güç : 1 kW / 230 V 50 Hz
- Gross Volume - Hacim :0,80 m³.
- Temperature range: 2 °C to + 8 °C
- Price - Fiyat : 1.925 €



K-ST70BZ19

Self Service Refrigerator With Cold Well/ Self Servis Buzdolabı

- Size - Boyut W: 1900 D : 700 H: 850 mm.
- Automatic defrost - Otomatik defrost
- Power- Güç : 1 kW / 230 V 50 Hz
- Gross Volume - Hacim :1,86 m³.
- Temperature range: 2 °C to + 8 °C
- Price - Fiyat : 2.284 €



K-ST70BZ24

Self Service Refrigerator/ Self Servis Buzdolabı

- Size - Boyut W: 2400 D : 700 H: 850 mm.
- Automatic defrost - Otomatik defrost
- Power- Güç : 1 kW / 230 V 50 Hz
- Gross Volume - Hacim 2,18 m³.
- Temperature range: 2 °C to + 8 °C
- Price - Fiyat : 2.578 €



Self Service Refregirator With Sink/Self Servis Buzdolabı Havuz Soğutmalı

K-S70BSH12

Self Service Refregirator With Sink/Self Servis Buzdolabı Havuz Soğutmalı

- Size - Boyut W: 1200 D : 700 H: 850 mm.
- Automatic defrost - Otomatik defrost
- Power- Güç : 1 kW / 230 V 50 Hz
- Soğutma havuzu : 3 x GN 1/1, maks. derinlik: 100 mm
- Gross Volume - Hacim :0,80 m³.
- Temperature range: 2 °C to + 8 °C
- Price - Fiyat : 2.013 €



K-S70BSH15

Service Unit With Cold Well/Self Servis Soğuk Havuz Soğutmalı

- Size - Boyut W: 1500 D : 700 H: 850 mm.
- Automatic defrost - Otomatik defrost
- Power- Güç : 1 kW / 230 V 50 Hz
- Gross Volume - Hacim: 0,98 m³.
- Cooling Well / Soğutma havuzu: 4 x GN 1/1 100 mm max depht
- Temperature range: 2 °C to + 8 °C
- Gn containers are not included- Gn kaplar dahil değildir.
- Price - Fiyat : 2.110 €



K-S70BSH19

Self Service Refregirator With Sink/Self Servis Buzdolabı Havuz Soğutmalı

- Size - Boyut W: 1900 D : 700 H: 850 mm.
- Automatic defrost - Otomatik defrost
- Power- Güç : 1 kW / 230 V 50 Hz
- Soğutma havuzu : 5 x GN 1/1, maks. derinlik: 100 mm
- Gross Volume - Hacim :1,86 m³.
- Temperature range: 2 °C to + 8 °C
- Price - Fiyat : 2.216 €





HOT FOOD COUNTERS

- Designed for display of warm food
- Made in stainless steel
- Interior led lighting
- Humidity control, thanks to water drawer to prevent the drying out of exposed products
- For GN 1/1 trays with maximum depth of 150 mm.
- Digital display showing the temperature
- Keeps the initial temperature (70°C / 80°C) of exposed products max. 2 hours with 5 °C difference
- Heating performance between 60°C -90°C at 23 °C and % 55 humidity condition
- Easy water drain with included bottom surface

SICAK YEMEK SERVİS HATTI

- Sıcak yiyeceklerin sunumu için tasarlanmıştır.
- Paslanmaz çelikten imal edilmiştir.
- İç led aydınlatma
- Nemlendirme yöntemi ile sunulan yiyeceklerin kuruması önlenir.
- Max. 150 mm. yükseklik ile GN 1/1'e uygundur.
- Digital sıcaklık göstergesi vardır.
- 70°C / 80°C başlangıç sıcaklığındaki yiyecekleri 2 saat boyunca 5 °C farkla koruyabilir.
- 23 °C ve % 55 nemli ortamda , yiyeceklerin ısısını 60 °C - 90 °C ye çıkabilir.
- Zemin tablasındaki eğim ile suyun kolay tahliyesi sağlanır.

Classic Hot Display Unit/Classic Dik Sıcak Teşhir

K-KT70SS12

Classic Hot Display Unit/Classic Dik Teşhir Sıcak Servis

- Size - Boyut W: 1200 D: 700 H: 850 / 1650 mm
- Display Capacity- Vitrin Kapasitesi: 440 lt
- Power- Güç : 2 kW / 230 V 50 Hz
- Lower Refrigerator - Alt Dolap : 300 lt
- Gross Volume - Hacim :2 m³
- Capacity of hot basin : 3 x GN 1/1, max. depth: 150 mm
- Sıcak havuz kapasitesi: 3 x GN 1/1, maks. derinlik: 150 mm
- Price - Fiyat : 2.013 €



K-KT70SS15

Classic Hot Display Unit/Classic Dik Sıcak Teşhir

- Size - Boyut W: 1500 D: 700 H: 850 / 1650 mm
- Display Capacity- Vitrin Kapasitesi: 580 lt
- Power- Güç : 3 kW / 230 V 50 Hz
- Lower Refrigerator - Alt Dolap Kapasite: 405 litre
- Gross Volume - Hacim: 2,5 m³
- Capacity of hot basin tray: 4 x GN 1/1, max. depth: 100 mm
- Sıcak havuz kapasitesi: 4 x GN 1/1, maks. derinlik: 100 mm
- Price-Fiyat: 3.150 €



Optional / Nova Hot Display Warming Cupboard Unit
Opsiyon / Nova Sıcak Teşhir Servis Sıcaklık Ünitesi

Self Service Benmaire/Benmari Servis Ünitesi

K-B70SK12E

Self Service Benmaire/Benmari Servis Ünitesi

Size - Boyut : 1200X700X850 mm
Power- Güç: 2,6 kW / 230 V 50 Hz
3xGN 1/1
max. depth: 150 mm
Price - Fiyat : 1.270 €

K-B70SK15E

Self Service Benmaire/Benmari Servis Ünitesi

Size - Boyut : 1500X700X850 mm
Power- Güç: 2,6 kW / 230 V 50 Hz
4xGN 1/1
max. depth: 150 mm
Price - Fiyat : 1.443 €

K-B70SK19E

Self Service Benmaire/Benmari Servis Ünitesi

Size - Boyut : 1900X700X850 mm
Power- Güç: 5,2 kW / 230 V 50 Hz
6xGN 1/1
max. depth: 150 mm
Price - Fiyat : 1.611 €

K-B70SK24E

Self Service Benmaire/Benmari Servis Ünitesi

Size - Boyut : 2400X700X850 mm
Power- Güç: 5,2 kW / 230 V 50 Hz
7xGN 1/1
max. depth: 150 mm
Price - Fiyat : 1.954 €

GN containers are included- Gn Kaplar dahildir.



Self Service Benmarie Warming Cupboard/ Benmari Sıcaklık Dolaplı Servis Ünitesi

K-B70SDT12E

Self Service Benmarie Warming Cupboard/

Benmari Sıcaklık Dolaplı Servis Ünitesi

Size - Boyut : 1200X700X850 mm
Power- Güç: 3,6 kW / 230 V 50 Hz
3 x GN 1/1
max. depth: 150 mm
Price - Fiyat : 1.637 €



K-B70SDT15E

Self Service Benmarie Warming Cupboard/

Benmari Sıcaklık Dolaplı Servis Ünitesi

Size - Boyut : 1500X700X850 mm
Power- Güç: 3,6 kW / 230 V 50 Hz
4x GN 1/1
max. depth: 150 mm
Price - Fiyat : 1.800 €



K-B70SDT18E

Self Service Benmarie Warming Cupboard/

Benmari Sıcaklık Dolaplı Servis Ünitesi

Size - Boyut : 1800x700x850 mm
Power- Güç: 4,9 kW / 230 V 50 Hz
5x GN 1/1
max. depth: 150 mm
Price - Fiyat : 1.910 €



K-B70SDT24E

Self Service Benmarie Warming Cupboard/

Benmari Sıcaklık Dolaplı Servis Ünitesi

Size - Boyut : 2400x700x850 mm
Power- Güç: 6,2 kW / 230 V 50 Hz
6x GN 1/1
max. depth: 150 mm
Price - Fiyat : 2.250 €



GN containers are included - Gn Kaplar dahildir.

Self Service Warming Cupboard/Sıcaklık Dolabı Servis Ünitesi

K-SD70TK14E

Self Service Warming Cupboard/Sıcaklık Dolabı Servis Ünitesi

- Size - Boyut 1400 D: 700 H:850
- Power- Güç: 1 kW / 230 V 50 Hz
- Gross Volume - Hacim: 1,14 m³
- Price - Fiyat : 1.344 €



K-SD70TK16E

Self Service Warming Cupboard/Sıcaklık Dolabı Servis Ünitesi

- Size - Boyut W: 1500 D: 700 H: 850
- Power- Güç: 1 kW / 230 V 50 Hz
- Gross Volume - Hacim: 1,25 m³
- Price - Fiyat : 1.392 €



K-SD70TK19E

Self Service Warming Cupboard/Sıcaklık Dolabı Servis Ünitesi

- Size - Boyut W:1900 D:700 H:850
- Power- Güç: 1 kW / 230 V 50 Hz
- Gross Volume - Hacim: 1,65 m³
- Price - Fiyat : 1.504 €



Couvert unit /Küver ünitesi

K-KU70ST70 700x700x850/1400 Price - Fiyat : 557 €

K-KU70ST10 1000x700x850/1400 Price - Fiyat : 630 €

K-KU70ST14 1400x700x850/1400 Price - Fiyat : 730 €

Capacity of hot basin :

3 pcs GN1/6 , 1 pcs GN 1/1 max. depth: 150 mm

GN containers are included- Gn Kaplar dahildir.



K-KU70YM80

Cutlery Unit Model/Yelken Model Küver

Size - Boyut W: 800 x 700 x 530 / 1630

Capacity of hot basin :

3 x GN 1/1 - 4x GN 1/1 - 5x GN 1/1 - 6x GN 1/1 - 7x GN 1/1 max. depth: 150 mm

GN containers are included- Gn Kaplar dahildir.

Price - Fiyat : 887 €



K-KU70UR70

Cutlery Unit Top Shelf/Küver Ünitesi Üst Raf

Size - Boyut W: 700 x 700 x 550

Capacity of hot basin :

5 Pcs GN 1/4 max. depth: 150 mm

Each shelf has a capacity of 50 cups,

GN containers are included- Gn Kaplar dahildir.

Price - Fiyat : 270 €



K-BU70UR70

Glass Service Unit Top Shelf/Bardak Servis Üst Raf

Size - Boyut W: 700 x 700 x 750

Glass capacity- Bardak Kapasitesi :

Each shelf has a capacity of 50 cups, total 150 cups capacity max. depth: 150 mm

Price - Fiyat : 358 €



K-TU70TD50E

Dishing Serving Unit/Tabak Servis Ünitesi

- Size - Boyut W: 500 D : 700 H: 850mm
- Plate Capacity- Tabak Kapasitesi: Ø28 or Ø32x 50 Pcs
- Power- Güç : 0,75 kW / 230 V 50 Hz
- Gross Volume - Hacim : 0,3 m³
- Price - Fiyat : 563 €



K-TU70TD50N

Dishing Serving Unit/Tabak Servis Ünitesi

- Size - Boyut W: 500 D : 700 H: 850mm
- Plate Capacity- Tabak Kapasitesi: Ø28 or Ø32x 50 Pcs
- Gross Volume - Hacim : 0,3 m³
- Price - Fiyat : 477 €



K-KS70CK70

Cashier Unit With Locked Drawer/

Kasa Servis Ünitesi (Çekmeceli Kilitli)

Size - Boyut W: 700x700x850 mm

Price - Fiyat : 504 €



K-KS70CK14

Cashier Unit With Locked Drawer/

Kasa Servis Ünitesi (Çekmeceli Kilitli)

Size - Boyut W: 1400x700x850 mm

Price - Fiyat : 790 €



Self Servis Nötr/Self Servis Nötr

K-NT70ST10	1000 x 700 x 850	Price - Fiyat : 522 €
K-NT70ST12	1200 x 700 x 850	Price - Fiyat : 564 €
K-NT70ST14	1400 x 700 x 850	Price - Fiyat : 605 €
K-NT70ST16	1600 x 700 x 850	Price - Fiyat : 646 €
K-NT70ST18	1800 x 700 x 850	Price - Fiyat : 685 €
K-NT70ST20	2000 x 700 x 850	Price - Fiyat : 729 €
K-NT70ST22	2200 x 700 x 850	Price - Fiyat : 770 €



Notr Service Unit (Slide Door)/Nötr Servis Ünitesi (Sürgü Kapılı)

K-NS70SK11	1100X700X850 mm	Price - Fiyat : 695 €
K-NS70SK13	1300X700X850 mm	Price - Fiyat : 746 €
K-NS70SK15	1500X700X850 mm	Price - Fiyat : 798 €
K-NS70SK17	1700X700X850 mm	Price - Fiyat : 837 €
K-NS70SK19	1900X700X850 mm	Price - Fiyat : 900 €
K-NS70SK21	2100X700X850 mm	Price - Fiyat : 936 €



K-UT70IK15

Inner Corner Service Unit/İç Köşe Uyum Servis Ünitesi

Size - Boyut W: 1500 x 850 x 850
Price - Fiyat : 544 €



K-UT70DK15

External Corner Service Unit/Dış Köşe Uyum Servis Ünitesi

Size - Boyut W: 1500 x 990 x 850
Price - Fiyat : 453 €



Folding Tray Sliding/Tepsi Kaydırma Hareketli Konsol

K-TK30HU70	700 x 300 x 150	Price - Fiyat : 147 €
K-TK30HU80	800 x 300 x 150	Price - Fiyat : 150 €
K-TK30HU90	900 x 300 x 150	Price - Fiyat : 153 €
K-TK30HU10	1000 x 300 x 150	Price - Fiyat : 155 €
K-TK30HU11	1100 x 300 x 150	Price - Fiyat : 158 €
K-TK30HU12	1200 x 300 x 150	Price - Fiyat : 161 €
K-TK30HU13	1300 x 300 x 150	Price - Fiyat : 164 €
K-TK30HU14	1400 x 300 x 150	Price - Fiyat : 166 €
K-TK30HU15	1500 x 300 x 150	Price - Fiyat : 169 €
K-TK30HU16	1600 x 300 x 150	Price - Fiyat : 172 €
K-TK30HU17	1700 x 300 x 150	Price - Fiyat : 175 €
K-TK30HU18	1800 x 300 x 150	Price - Fiyat : 161 €
K-TK30HU19	1900 x 300 x 150	Price - Fiyat : 177 €
K-TK30HU20	2000 x 300 x 150	Price - Fiyat : 214 €
K-TK30HU21	2100 x 300 x 150	Price - Fiyat : 216 €
K-TK30HU22	2200 x 300 x 150	Price - Fiyat : 219 €
K-TK30HU23	2300 x 300 x 150	Price - Fiyat : 222 €
K-TK30HU24	2400 x 300 x 150	Price - Fiyat : 225 €



Tray Sliding Stable/Tepsi Kaydırma Sabit Konsol

K-TK30SU70	700 x 300 x 150	Price - Fiyat : 136 €
K-TK30SU80	800 x 300 x 150	Price - Fiyat : 140 €
K-TK30SU90	900 x 300 x 150	Price - Fiyat : 143 €
K-TK30SU10	1000 x 300 x 150	Price - Fiyat : 144 €
K-TK30SU11	1100 x 300 x 150	Price - Fiyat : 147 €
K-TK30SU12	1200 x 300 x 150	Price - Fiyat : 150 €
K-TK30SU13	1300 x 300 x 150	Price - Fiyat : 153 €
K-TK30SU14	1400 x 300 x 150	Price - Fiyat : 156 €
K-TK30SU15	1500 x 300 x 150	Price - Fiyat : 159 €
K-TK30SU16	1600 x 300 x 150	Price - Fiyat : 161 €
K-TK30SU17	1700 x 300 x 150	Price - Fiyat : 164 €
K-TK30SU18	1800 x 300 x 150	Price - Fiyat : 167 €
K-TK30SU19	1900 x 300 x 150	Price - Fiyat : 169 €
K-TK30SU20	2000 x 300 x 150	Price - Fiyat : 172 €
K-TK30SU21	2100 x 300 x 150	Price - Fiyat : 175 €
K-TK30SU22	2200 x 300 x 150	Price - Fiyat : 178 €
K-TK30SU23	2300 x 300 x 150	Price - Fiyat : 180 €
K-TK30SU24	2400 x 300 x 150	Price - Fiyat : 183 €



Lumi Sneeze Guard With Lighting Shelf/Lumi Model Nefeslik (Aydınlatma Rafı)

K-NF70AR70	700 x 300 x 550	Price - Fiyat : 357 €
K-NF70AR80	800 x 300 x 550	Price - Fiyat : 373 €
K-NF70AR90	900 x 300 x 550	Price - Fiyat : 390 €
K-NF70AR10	1000 x 300 x 550	Price - Fiyat : 410 €
K-NF70AR11	1100 x 300 x 550	Price - Fiyat : 418 €
K-NF70AR12	1200 x 300 x 550	Price - Fiyat : 457 €
K-NF70AR13	1300 x 300 x 550	Price - Fiyat : 465 €
K-NF70AR14	1400 x 300 x 550	Price - Fiyat : 472 €
K-NF70AR15	1500 x 300 x 550	Price - Fiyat : 481 €
K-NF70AR16	1600 x 300 x 550	Price - Fiyat : 489 €
K-NF70AR17	1700 x 300 x 550	Price - Fiyat : 550 €
K-NF70AR18	1800 x 300 x 550	Price - Fiyat : 559 €
K-NF70AR19	1900 x 300 x 550	Price - Fiyat : 569 €
K-NF70AR20	2000 x 300 x 550	Price - Fiyat : 577 €
K-NF70AR21	2100 x 300 x 550	Price - Fiyat : 586 €
K-NF70AR22	2200 x 300 x 550	Price - Fiyat : 658 €
K-NF70AR23	2300 x 300 x 550	Price - Fiyat : 667 €
K-NF70AR24	2400 x 300 x 550	Price - Fiyat : 698 €



2100 mm. After the width, three pipe feet are used in the products.2100 mm. genişlikten sonra, ürünlerde üç boru ayak kullanılır.

Glazed Prevention Cough With Glass Shelf/Glazed Model Nefeslik (Cam Rafı)

K-NF70CR70	700 x 300 x 550	Price - Fiyat : 333 €
K-NF70CR80	800 x 300 x 550	Price - Fiyat : 349 €
K-NF70CR90	900 x 300 x 550	Price - Fiyat : 359 €
K-NF70CR10	1000 x 300 x 550	Price - Fiyat : 368 €
K-NF70CR11	1100 x 300 x 550	Price - Fiyat : 374 €
K-NF70CR12	1200 x 300 x 550	Price - Fiyat : 405 €
K-NF70CR13	1300 x 300 x 550	Price - Fiyat : 412 €
K-NF70CR14	1400 x 300 x 550	Price - Fiyat : 420 €
K-NF70CR15	1500 x 300 x 550	Price - Fiyat : 438 €
K-NF70CR16	1600 x 300 x 550	Price - Fiyat : 447 €
K-NF70CR17	1700 x 300 x 550	Price - Fiyat : 484 €
K-NF70CR18	1800 x 300 x 550	Price - Fiyat : 496 €
K-NF70CR19	1900 x 300 x 550	Price - Fiyat : 503 €
K-NF70CR20	2000 x 300 x 550	Price - Fiyat : 507 €
K-NF70CR21	2100 x 300 x 550	Price - Fiyat : 515 €
K-NF70CR22	2200 x 300 x 550	Price - Fiyat : 564 €
K-NF70CR23	2300 x 300 x 550	Price - Fiyat : 580 €
K-NF70CR24	2400 x 300 x 550	Price - Fiyat : 608 €



2100 mm. After the width, three pipe feet are used in the products.2100 mm. genişlikten sonra, ürünlerde üç boru ayak kullanılır.

Edna Sneeze Guard With Bent Glass /Edna Model Nefeslik (Bombe Camlı)

K-NF70BC70	700 x 300 x 550	Price - Fiyat : 219 €
K-NF70BC80	800 x 300 x 550	Price - Fiyat : 254 €
K-NF70BC90	900 x 300 x 550	Price - Fiyat : 289 €
K-NF70BC10	1000 x 300 x 550	Price - Fiyat : 323 €
K-NF70BC11	1100 x 300 x 550	Price - Fiyat : 357 €
K-NF70BC12	1200 x 300 x 550	Price - Fiyat : 392 €
K-NF70BC13	1300 x 300 x 550	Price - Fiyat : 426 €
K-NF70BC14	1400 x 300 x 550	Price - Fiyat : 460 €
K-NF70BC15	1500 x 300 x 550	Price - Fiyat : 494 €
K-NF70BC16	1600 x 300 x 550	Price - Fiyat : 529 €
K-NF70BC17	1700 x 300 x 550	Price - Fiyat : 563 €
K-NF70BC18	1800 x 300 x 550	Price - Fiyat : 597 €
K-NF70BC19	1900 x 300 x 550	Price - Fiyat : 631 €
K-NF70BC20	2000 x 300 x 550	Price - Fiyat : 666 €
K-NF70BC21	2100 x 300 x 550	Price - Fiyat : 700 €
K-NF70BC22	2200 x 300 x 550	Price - Fiyat : 734 €
K-NF70BC23	2300 x 300 x 550	Price - Fiyat : 768 €
K-NF70BC24	2400 x 300 x 550	Price - Fiyat : 803 €



Simple Prevention Cough With Stainless Steel Shelf/Simple Model Nefeslik (Paslanmaz Rafli)

K-NF70PR70	700 x 300 x 550	Price - Fiyat : 140 €
K-NF70PR80	800 x 300 x 550	Price - Fiyat : 144 €
K-NF70PR90	900 x 300 x 550	Price - Fiyat : 147 €
K-NF70PR10	1000 x 300 x 550	Price - Fiyat : 151 €
K-NF70PR11	1100 x 300 x 550	Price - Fiyat : 156 €
K-NF70PR12	1200 x 300 x 550	Price - Fiyat : 161 €
K-NF70PR13	1300 x 300 x 550	Price - Fiyat : 166 €
K-NF70PR14	1400 x 300 x 550	Price - Fiyat : 171 €
K-NF70PR15	1500 x 300 x 550	Price - Fiyat : 176 €
K-NF70PR16	1600 x 300 x 550	Price - Fiyat : 181 €
K-NF70PR17	1700 x 300 x 550	Price - Fiyat : 185 €
K-NF70PR18	1800 x 300 x 550	Price - Fiyat : 189 €
K-NF70PR19	1900 x 300 x 550	Price - Fiyat : 192 €
K-NF70PR20	2000 x 300 x 550	Price - Fiyat : 196 €
K-NF70PR21	2100 x 300 x 550	Price - Fiyat : 200 €
K-NF70PR22	2200 x 300 x 550	Price - Fiyat : 207 €
K-NF70PR23	2300 x 300 x 550	Price - Fiyat : 211 €
K-NF70PR24	2400 x 300 x 550	Price - Fiyat : 236 €



2100 mm. After the width, three pipe feet are used in the products.2100 mm. genişlikten sonra, ürünlerde üç boru ayak kullanılır.

KUSINA[®]

DROP - IN DISPLAYS • DROPIŒ VİTRİNLER



**C
ÖFFE**

Drop-In Displays/Dropin Vitrinler



COLD FOOD DISPLAYS

- Digital control panel.
- Digital thermostat
- On-off switch
- Temperature adjustment
- Temperature display
- Led lighting siperfectly illuminated inside the cabinet.
- The operating temperature is + 2 / + 8 ° C at an ambient temperature of 24 ° C and a hum d ty level of 55%.
- Su table for GN1 / 1 bas n w th 150 mm height.
- Automatic defrost.
- Ideal for presenting chilled snacks or cakes

SOĞUK YEMEK SERGİLEME

- Dijital kontrol panel.
- Dijital termostat
- Açma-Kapama sviçi
- Sıcaklık ayarı
- Sıcaklık göstergesi
- Led aydınlatma dolap içi mükemmel şekilde aydınlanır.
- 24°C ortam sıcaklığında ve %55 nem seviyesinde çalışma ısısı +2/+8°C'dir.
- 150 mm yükseklikte GN1/1 küvete uygundur.
- Otomatik defrost.
- Soğutulmuş atıştırmalıklar veya kekler sunmak için ideal

Drop-In Displays/Dropin Vitrinler

Cold Displays/Soğuk Vitrinler

T-SA73DK11

Cold Display Unit/Soğuk Teşhir Ünitesi

Dim(mm)LxDxH - Ebat (mm): W: 1100 D : 730 H: 650 / 1400 mm
Power - Güç : 1 kW/230 V /1N PE 50 Hz
Capacity - Kapasite : 140 lt
Gross Volume - Hacim : 1,3 m³
Price - Fiyat : 3.362 €



T-SA73DK14

Cold Display Unit/Soğuk Teşhir Ünitesi

Dim(mm)LxDxH - Ebat (mm): W: 1400 D : 730 H: 650 / 1400 mm
Power - Güç : 1 kW/230 V/1N PE 50 Hz
Capacity - Kapasite : 200 lt
Gross Volume - Hacim : 1,6 m³
Price - Fiyat : 4.180 €



Drop-In Displays/Dropin Vitrinler

Cold Displays Open Front Side Unit/Önü Açık Soğuk Vitrinler

T-SA73DA11

Cold Displays Open Front Side Unit/Önü Açık Soğuk Vitrin

Dim(mm)LxDxH - Ebat (mm): W: 1100 D: 730 H: 650/1400 mm
Power - Güç : 1,5 kW/230V/1N PE 50 Hz
Gross Weight - Ağırlık : 140 lt.
Gross Volume - Hacim : 1,6 m³
Price - Fiyat : 3.136 €



T-SA73DA14

Cold Displays Open Front Side Unit/Önü Açık Soğuk Vitrin

Dim(mm)LxDxH - Ebat (mm): W: 1400 D: 730 H: 650 / 1400 mm
Power - Güç : 1,5 kW/230V/1N PE 50 Hz
Capacity - Kapasite : 200 lt
Gross Volume - Hacim : 2,1 m³
Price - Fiyat : 3.483 €





HOT FOOD DISPLAYS

- Designed for display of warm food
- Made in stainless steel
- Interior led lighting
- Humidity control, thanks to water drawer to prevent the drying out of exposed products
- For GN 1/1 trays with maximum depth of 150 mm.
- Digital display showing the temperature
- Keeps the initial temperature (70°C / 80°C) of exposed products max. 2 hours with 5 °C difference
- Heating performance between 60°C -90°C at 23 °C and % 55 humidity condition
- Easy water drain with included bottom surface

SICAK YEMEK SERGİLEME

- Sıcak yiyeceklerin sunumu için tasarlanmıştır.
- Paslanmaz çelikten imal edilmiştir.
- Led ile aydınlatılır.
- Nemlendirme yöntemi ile sunulan yiyeceklerin kuruması önlenir.
- Max. 150 mm. yükseklik ile GN 1/1'e uygundur.
- Dijital sıcaklık göstergesi vardır.
- 70°C / 80°C başlangıç sıcaklığındaki yiyecekleri 2 saat boyunca 5 °C farkla koruyabilir.
- 23 °C ve % 55 nemli ortamda , yiyeceklerin ısısını 60 °C - 90 °C ye çıkabilir.
- Zemin tablasındaki eğim ile suyun kolay tahliyesi sağlanır.

Drop-In Displays/Dropin Vitrinler

Hot Display/Sıcak Vitrinler

T-SA73DS11

Hot Display/Sıcak Vitrin

Dim(mm)LxDxH – Ebat (mm): W: 1100 D : 730 H: 880/1650 mm
Power - Güç : 1 kW/ 230 V /1N PE 50 Hz
Gross Weight - Ağırlık : 90 Kg.
Capacity - Kapasite : 140 lt
Gross Volume - Hacim : 1,3 m³
Price - Fiyat : 1.578 €



T-SA73DS14

Hot Display/Sıcak Vitrin

Dim(mm)LxDxH – Ebat (mm): W: 1400 D : 730 H: 880/1650 mm
Power - Güç : 1 kW / 230 V /1N PE 50 Hz
Gross Weight - Ağırlık : 135 Kg.
Capacity - Kapasite : 155 lt
Gross Volume - Hacim : 1,5 m³
Price - Fiyat : 2.128 €



Drop-In Displays/Dropin Vitrinler

Notr Displays/Notr Vitrinler

T-SA73DN11

Notr Displays /Notr Vitrinler

Dim(mm)LxDxH - Ebat (mm): W: 1100 D : 730 H: 880/1650 mm
Gross Weight - Ağırlık : 90 Kg.
Capacity - Kapasite : 140 lt
Gross Volume - Hacim : 1,3 m³
Price - Fiyat : 940 €



T-SA73DN14

Notr Displays /Notr Vitrinler

Dim(mm)LxDxH - Ebat (mm): W: 1400 D : 730 H: 880/1650 mm
Gross Weight - Ağırlık : 135 Kg.
Capacity - Kapasite : 155 lt
Gross Volume - Hacim : 1,5 m³
Price - Fiyat : 1.095 €



Drop-In Displays/Dropin Vitrinler

Cold serving unit/Soğuk Servis Ünitesi

T-SA73SS12

Cold Serving Unit/Soğuk Servis Ünitesi

Dim(mm)LxDxH - Ebat (mm): W: 1200 D: 730 H: 1050 mm
Power - Güç : 1 kW/230V/1N PE 50 Hz
Gross Weight - Ağırlık : 90 Kg
Capacity - Kapasite : 3 x GN 1/1
Gross Volume - Hacim : 1,3 m³
Price - Fiyat : 1.809 €



T-SA73SS15

Cold Serving Unit/Soğuk Servis Ünitesi

Dim(mm)LxDxH - Ebat (mm): W:1500 D:730 H:1050 mm
Power - Güç : 1 kW/230V/1N PE 50 Hz
Capacity - Kapasite : 4 x GN 1/1
Gross Volume - Hacim : 1,48 m³
Price - Fiyat : 2.173 €



T-SA73SS18

Cold Serving Unit/Soğuk Servis Ünitesi

Dim(mm)LxDxH - Ebat (mm): W:1800 D: 730 H:1050
Power - Güç : 1 kW/230V/1N PE 50 Hz
Capacity - Kapasite : 50 Pcs. Ø 26-32 mm
Gross Volume - Hacim : 1,6 m³
Price - Fiyat : 2.436 €



Drop-In Displays/Dropin Vitrinler

Bainmarie Unit/Benmari Ünitesi

T-SA73AB12

Bainmarie Unit/Benmari Ünitesi

Dim(mm)LxDxH – Ebat (mm): W: 1200 D : 730 H: 810 mm
Power – Güç : 3 kW/230V/1N PE 50 Hz
Gross Weight – Ağırlık : 70 Kg.
Capacity – Kapasite : 3 x GN 1/1
Gross Volume – Hacim : 1,3 m³
Price – Fiyat : 1.258 €



T-SA73AB15

Bainmarie Unit/Benmari Ünitesi

Dim(mm)LxDxH – Ebat (mm): W: 1500 D : 730 H: 810 mm
Power – Güç : 3 kW/230V/1N PE 50 Hz
Gross Weight – Ağırlık : 80 Kg.
Capacity – Kapasite : 4 x GN 1/1
Gross Volume – Hacim : 1,48 m³
Price – Fiyat : 1.593 €



T-SA73AB18

Bainmarie Unit/Benmari Ünitesi

Dim(mm)LxDxH – Ebat (mm): W: 1800 D : 730 H: 810 mm
Power – Güç : 4,5 kW/230V/1N PE 50 Hz
Gross Weight – Ağırlık : 90 Kg.
Capacity – Kapasite : 5 x GN 1/1
Gross Volume – Hacim : 1,6 m³
Price – Fiyat : 1.833 €



Drop-In Displays/Dropin Vitrinler

Bainmarie Unit With Bowls/Benmari Çorba Ünitesi

T-SA73BC12

Bainmarie Unit With Bowls/Benmari Çorba Ünitesi

Dim(mm)LxDxH – Ebat (mm): W: 1200 D : 730 H: 930 mm
Power - Güç : 3,7 kW/230 V 1N PE
Gross Weight - Ağırlık : 70 Kg.
Capacity - Kapasite : 2 x GN 1/1
Gross Volume - Hacim : 1,3 m³
Soup boiler capacity : 17 lt per boiler
Çorba kazanı kapasitesi : Kazan başına 17 lt.
Price - Fiyat : 1.311 €



T-SA73BC15

Bainmarie Unit With Bowls/Benmari Çorba Ünitesi

Dim(mm)LxDxH – Ebat (mm): W: 1500 D : 730 H: 930 mm
Power - Güç : 5,2 kW/230 V 1N PE
Gross Weight - Ağırlık : 80 Kg.
Capacity - Kapasite : 4 x GN 1/1
Gross Volume - Hacim : 1,48 m³
Soup boiler capacity : 17 lt per boiler
Çorba kazanı kapasitesi : Kazan başına 17 lt.
Price - Fiyat : 1.675 €



T-SA73BC18

Bainmarie Unit With Bowls/Benmari Çorba Ünitesi

Dim(mm)LxDxH – Ebat (mm): W: 1800 D : 730 H: 930 mm
Power - Güç : 5,2 kW/230 V 1N PE
Gross Weight - Ağırlık : 90 Kg.
Capacity - Kapasite : 4 x GN 1/1
Gross Volume - Hacim : 1,6 m³
Soup boiler capacity : 17 lt per boiler
Çorba kazanı kapasitesi : Kazan başına 17 lt.
Price - Fiyat : 1.953 €



Drop-In Displays/Dropin Vitrinler

T-SA40TD70-E

Plate Cartridge/Tabak Kartuşu

Plate Capacity	: 50 Pcs. Ø 26-32 mm
Dim(mm)LxDxH - Ebat (mm)	: Ø 450 H: 750 mm
Power - Güç	: 0,75 kW / 230V/1N 1PE 50 Hz
Gross Weight - Ağırlık	: 24 Kg.
Capacity - Kapasite	: 50 Kg.
Gross Volume - Hacim	: 0,48 m ³
Price - Fiyat	: 406 €

Plate cartridge discharge dimensions - Tabak kartuşu boşaltma ölçüleri



T-SA40TD70-N

Notr Plate Cartridge/Nötr Tabak Kartuşu

Plate Capacity - Tabak Kapasite	: 50 Pcs. Ø 26-32 mm
Dim(mm)LxDxH - Ebat (mm)	: Ø 450 H: 750 mm
Gross Weight - Ağırlık	: 24 Kg.
Capacity - Kapasite	: 50 Kg.
Gross Volume - Hacim	: 0,530 m ³
Price - Fiyat	: 380 €

The product is neutral - Ürün nötrdür.



Drop-In Displays/Dropin Vitrinler

T-SA60CU90

Carving Unit/Carving Ünitesi

Dim(mm)LxDxH - Ebat (mm): W: 900 D : 600 H: 650 mm
Power - Güç : 1 kW/230V/1N PE 50 Hz
Gross Weight - Ağırlık : 17 kg
Capacity - Kapasite : 2 GN 1/1
Gross Volume - Hacim : 0,55 m³
Price - Fiyat : 881 €



T-SA44PD90

Warmer Unit/Sıcaklık Ünitesi

Dim(mm)LxDxH - Ebat (mm): W: 900 D : 440 H: 700 mm
Gross Weight - Ağırlık : 39 kg
Gross Volume - Hacim : 0,57 m³
Power - Güç : 1 kW/230V/1N PE 50 Hz
Price - Fiyat : 972 €



T-SA73KU70

Cutlery Unit/Küver Ünitesi

Dim(mm)LxDxH - Ebat (mm): W: 700 D : 700 H: 910 mm
Gross Weight - Ağırlık : 20 Kg
Capacity - Kapasite : Glasses-Bardak: 36-40 Pcs. 1xGN 2/1 -- 4x GN 1/4
Gross Volume - Hacim : 0,74 m³
Price - Fiyat : 631 €



KUSINA[®]

TROLLEYS • ARABALAR

KUSINA

Trolleys/Arabalar

2A SA602K 90

Service Trolley Two Shelves/ Servis Arabası İki Katlı

Dim(mm)LxDxH - Ebat (mm): 900x600x850
Gross Volume - Hacim : 0,6 m³
Price - Fiyat : 186 €

- 4 swivel castors (2 with brakes) - 4 döner tekerlekli ikisi kilitli.
- Carrying capacity - Taşıma kapasitesi: 80 kg.
- Shelf size approx:- Raf ebatları yaklaşık : 875x575 mm
- Distance between shelves: Raflar arası mesafe: 540 mm
- Pipe size - Boru çapı : (Ø) 25
- Pipe thickness-Boru kalınlık: 1 mm
- Demontage - Demonte
- 430 Quality - 430 Kalite



2A SA603K 90

Service Trolley Three Shelves/ Servis Arabası Üç Katlı

Dim(mm)LxDxH - Ebat (mm): 900x600x850
Gross Volume - Hacim : 0,59 m³
Price - Fiyat : 243 €

- 4 swivel castors (2 with brakes) - 4 döner tekerlekli ikisi kilitli.
- Carrying capacity - Taşıma kapasitesi: 110 kg.
- Shelf size approx:- Raf ebatları yaklaşık : 875x575 mm
- Distance between shelves: Raflar arası mesafe: 260 mm
- Pipe size - Boru çapı : (Ø) 25
- Pipe thickness-Boru kalınlık: 1 mm
- Demontage - Demonte
- 430 Quality - 430 Kalite



BT60PR60

Basket Trolley/ Kaset Taşıma Arabası

Dim(mm)LxDxH - Ebat (mm): 600x600x850
Gross Volume - Hacim : 0,4 m³
Price - Fiyat : 182 €

- 2 fixed castors, 2 swivel castors Ø 125 - 2 sabit, 2 döner tekerlek Ø 125
- Carrying capacity - Taşıma kapasitesi: 150 kg.



Trolleys/Arabalar

2A KZ70TA 90

Pot Carrying Trolley/Kazan Taşıma Arabası

Dim(mm)LxDxH - Ebat (mm): 900x700x500/900
Gross Volume - Hacim : 0,68 m³
Price - Fiyat : 328 €

- 4 swivel castors (2 with brakes) - 4 döner tekerlekli ikisi kilitli.
- Carrying capacity - Taşıma kapasitesi: 120 kg.



2A BTA60H 90

Dirty Dish Collect Trolley/Bulaşık Toplama Arabası

Dim(mm)LxDxH - Ebat (mm): 900x600x850
Gross Volume - Hacim : 0,59 m³
Price - Fiyat : 279 €

- 4 swivel castors (2 with brakes) - 4 döner tekerlekli ikisi kilitli.
- Carrying capacity - Taşıma kapasitesi: 125 kg.
- Basin size approx:- Havuz ebatları yaklaşık : 1000x590x145 mm
- Distance between shelves: Raflar arası mesafe: 450 mm



2A US50TA 60

Flour And Sugar Trolley/Un Şeker Arabası

Dim(mm)LxDxH - Ebat (mm): 600x500x500
Gross Volume - Hacim : 0,25 m³
Price - Fiyat : 243 €

- 4 swivel castors (2 with brakes) - 4 döner tekerlekli ikisi kilitli.
- Carrying capacity - Taşıma kapasitesi: 140 lt.
- Basin size approx:- Havuz ebatları yaklaşık : 681x481x328 mm



Trolleys/Arabalar

2A IS60CA 90

Wet Laundry Trolley/İslak Çamaşır Arabası

Dim(mm)LxDxH - Ebat (mm): 900x600x850
Gross Volume - Hacim : 0,59 m³
Price - Fiyat : 265 €

- 4 swivel castors (2 with brakes) - 4 döner tekerlekli ikisi kilitli.
- Carrying capacity - Taşıma kapasitesi: 90 lt.
- Basin size approx:- Havuz ebatları yaklaşık : 550x854x196 mm



2AYT55TA 55

Tray Dispanser/Yaylı Tepsi Taşıma Arabası

Dim(mm)LxDxH - Ebat (mm): 550x550x850
Gross Volume - Hacim : 0,40 m³
Weight - Ağırlık : 25 kg
Price - Fiyat : 682 €

- 4 swivel castors (2 with brakes) - 4 döner tekerlekli ikisi kilitli.
- Tray capacity - Tepsi kapasitesi: 50 pc.
- Tray Size - Tepsi Ölçüleri: 370x530 mm.



2AMZ60TA 90

Material carrying trolley

Malzeme Taşıma Arabası 304 Kalite & 430 Kalite

Dim(mm)LxDxH - Ebat (mm): 900x600x850
Gross Volume - Hacim : 0,6 m³
Weight - Ağırlık : 24 kg
Price - Fiyat : 186 €

- 2 fixed castors, 2 swivel castors Ø 125 - 2 sabit, 2 döner tekerlek Ø 125
- Carrying capacity - Taşıma kapasitesi: 140 kg.



Trolleys/Arabalar

TTA11GN17

Tray Trolley 17 Shelves

Tepsi Taşıma Arabası 17 Raflı GN 1/1

Dim(mm)LxDxH - Ebat (mm): 385x580x1600

Gross Volume - Hacim : 0,60 m³

Price - Fiyat : 314 €

- 4 swivel castors (2 with brakes) - 4 döner tekerlekli ikisi kilitli.
- Tray capacity - GN 1/1 x17 pcs max h:65 mm



Demontage - Demonte



TTA11GN17D

Demontage Carry Tray Trolley/Demonte Tepsi Taşıma Arabası

Dim(mm)LxDxH - Ebat (mm): 385x580x1600

Gross Volume - Hacim : 0,60 m³

Price - Fiyat : 396 €

- 4 swivel castors (2 with brakes) - 4 döner tekerlekli ikisi kilitli.
- Capacity - Kapasite :GN 1/1 x 17 pcs max. h: 65 mm



Trolleys/Arabalar

BA65G140

Electrical Bainmarie Trolley With GN 1/1 Containers

1/1 Benmari Arabası Elektrikli

Dim(mm)LxDxH - Ebat (mm): 400x650x850
Gross Volume - Hacim : 0,35 m³
Weight - Ağırlık : 28 kg
Power - Güç : 1 kW/230V/1N PE 50 Hz
Price - Fiyat : 893 €

** Gn containers are not included- Gn kaplar dahil değildir.



BA65G310

Electrical Bainmarie Trolley With 3 Gn 1/1 Containers

GN 1/1 3 Adet Benmari Arabası Elektrikli

Dim(mm)LxDxH - Ebat (mm): 650X1100X850
Gross Volume - Hacim : 0,85 m³
Weight - Ağırlık : 41 kg
Power - Güç : 2,5 kW/230V/1N PE 50 Hz
Price - Fiyat : 1.134 €

** Gn containers are not included- Gn kaplar dahil değildir.



BA80G280

Electrical Bainmarie Trolley With GN 2/1 Containers

GN 2/1 Benmari Arabası Elektrikli

Dim(mm)LxDxH - Ebat (mm): 650X800X850
Gross Volume - Hacim : 0,85 m³
Weight - Ağırlık : 35 kg
Power - Güç : 0,6 kW/230V/1N PE 50 Hz
Price - Fiyat : 1.065 €

** Gn containers are not included- Gn kaplar dahil değildir.



Trolleys/Arabalar

TI90PL70

Electrical Plate Heating Platform

Tabak ısıtma Platformu Elektrikli

Dim(mm)LxDxH - Ebat (mm): 530x1000x850
Gross Volume - Hacim : 0,65 m³
Weight - Ağırlık : 75 kg
Power - Güç : 0,75 kW/230V/1N PE 50 Hz
Price - Fiyat : 2.164 €

- 4 swivel castors (2 with brakes) - 4 döner tekerlekli ikisi kilitli.
- Plate capacity - Tabak kapasitesi: 250 pc.
- Plate size: Tabak Ölçüsü: * Ø 26-32



TI48AT53

Electrical Plate Heating

Tabak ısıtma Arabası Tekli

Dim(mm)LxDxH - Ebat (mm): 530x480x850
Gross Volume - Hacim : 0,34 m³
Power - Güç : 0,75 kW/230V/1N PE 50 Hz
Price - Fiyat : 866 €

- 4 swivel castors (2 with brakes) - 4 döner tekerlekli ikisi kilitli.
- Plate capacity - Tabak kapasitesi: 50 pc.
- Plate size: Tabak Ölçüsü: * Ø 26-32



TI10AC53

Electrical Plate Heating

Tabak ısıtma Arabası İki

Dim(mm)LxDxH - Ebat (mm): 530x1000x850
Gross Volume - Hacim : 0,65 m³
Power - Güç : 1,5 kW/230V/1N PE 50 Hz
Price - Fiyat : 1.454 €

- 4 swivel castors (2 with brakes) - 4 döner tekerlekli ikisi kilitli.
- Plate capacity - Tabak kapasitesi: 50 pc.
- Plate size: Tabak Ölçüsü: * Ø 26-32



Trolleys/Arabalar

KS70YD10

Electrical Hot Food Service Trolley

Kat Sıcak Yemek Dağıtım Arabası Elektrikli

Dim(mm)LxDxH - Ebat (mm): 1000x700x850
Gross Volume - Hacim : 0,83 m³
Weight - Ağırlık : 80 kg
Power - Güç : 0,6 kW/230V/1N PE 50 Hz
Price - Fiyat : 1.149 €

- 4 swivel castors (2 with brakes) - 4 döner tekerlekli ikisi kilitli.
- GN capacity - Gn kapasitesi: 4 x GN 1/2 , 3 x GN 1/6 max.150 mm



TY68DA12

Electrical Telescopic Food Service Trolley

Telaskobik Yemek Dağıtım Arabası Elektrikli

Dim(mm)LxDxH - Ebat (mm): 1200x680x950
Gross Volume - Hacim : 0,85 m³
Weight - Ağırlık : 124 kg
Power - Güç : 0,6 kW/230V/1N PE 50 Hz
Price - Fiyat : 2.453 €

- 4 swivel castors (2 with brakes) - 4 döner tekerlekli ikisi kilitli.
- GN capacity - Gn kapasitesi: 3 x GN 1/1 . 150 mm
- Base Unit GN capacity - Alt Ünite Gn kapasitesi: 2 x GN 1/1 . 150 mm



2A ET74AR 60 Meat-Fish Thawing Trolley Et-Balık Çözündürme Arabası

Dim(mm)LxDxH - Ebat (mm): 640x740x1600
Price - Fiyat : 1.082 €

- 4 swivel castors (2 with brakes) - 4 döner tekerlekli ikisi kilitli.
- GN capacity - Gn kapasitesi: 6 x GN 1/1 . 150 mm



Trolleys/Arabalar

ST50EY50

Dish Trolley/Bulaşık Basma Arabası

Dim(mm)LxDxH - Ebat (mm): 600x500x700
Gross Volume - Hacim : 0,33 m³
Price - Fiyat : 354 €



ST50ES60

Vegetable Soaking Trolley/Sebze Basma Arabası

Dim(mm)LxDxH - Ebat (mm): 600x500x700
Gross Volume - Hacim : 0,33 m³
Price - Fiyat : 391 €



MZ36KT36

Material Trolley/Malzeme Arabası

Dim(mm)LxDxH - Ebat (mm): 560x360x400/850
Gross Volume - Hacim : 0,60 m³
Price - Fiyat : 155 €

- 4 swivel castors (2 with brakes) - 4 döner tekerlekli ikisi kilitli.
- GN capacity - GN kapasitesi: GN 1/1 max height: 200 mm



Trolleys/Arabalar

2A KU60CA 90

Dry Laundry Trolley/Kuru Çamaşır Arabası

Dim(mm)LxDxH - Ebat (mm): 900x600x850

Gross Volume - Hacim : 0,59 m³

Price - Fiyat : 360 €

- 4 swivel castors (2 with brakes) - 4 döner tekerlekli ikisi kilitli.
- Carrying capacity - Taşıma kapasitesi: 90 lt.
- Basin size approx:- Havuz ebatları yaklaşık : 550x854x196 mm



35524041

Waste Trolley/Çöp Arabası

Dim(mm)LxDxH - Ebat (mm): 40x40

Gross Volume - Hacim : 0,07 m³

Price - Fiyat : 220 €



2A TA73TT 98

Dish Trolley/Tabak Arabası

Dim(mm)LxDxH - Ebat (mm): 980x435x790

Gross Volume - Hacim : 0,84 m³

Price - Fiyat : 587 €

- 4 swivel castors (2 with brakes) - 4 döner tekerlekli ikisi kilitli.
- Plate capacity - Tabak kapasitesi: 200 pc.
- Plate size: Tabak Ölçüsü: * Ø 26-32



Shelving Systems/Raf Sistemleri/İstif Rafı

Shelf Unit/İstif Rafı Düz Tablalı

- Stainless steel - Paslanmaz çelik
- Durable - Dayanıklı
- Adjustable height legs - Yüksekliği ayarlanabilir ayaklar
- Stainless steel square profile 40x40 mm - 40x40 paslanmaz kutu profil
- Normal shelves : 100 kg/m load capacity - Her rafta 100 kg/ m taşıma kapasitesi.



Code/Kod	Size/Boyut	Weight/Ağırlık	m ³	Price/Fiyat
2R IR40DT 14	1400x800x1600	53 kg	1.79	725 €
2R IR40DT 16	1600x400x1600	30 kg	1.02	519 €
2R IR60DT 16	1600x600x1600	45 kg	1.53	636 €
2R IR80DT 16	1600x800x1600	61 kg	2.04	788 €
2R IR40DT 19	1900x400x1600	36 kg	1.21	566 €
2R IR60DT 19	1900x600x1600	53 kg	1.82	704 €
2R IR80DT 19	1900x800x1600	71 kg	2.43	937 €
2R IR40DT 24	2400x400x1600	46 kg	1.53	688 €
2R IR60DT 24	2400x600x1600	68 kg	2.30	861 €

Stainless Steel Perforated Shelf/Paslanmaz Çelikten İmal Perfore Tablalar

- Stainless steel - Paslanmaz çelik
- Durable - Dayanıklı
- Adjustable height legs - Yüksekliği ayarlanabilir ayaklar
- Stainless steel square profile 40x40 mm - 40x40 paslanmaz kutu profil
- Normal shelves : 110 kg/m load capacity - Her rafta 100 kg/ m taşıma kapasitesi.



Code/Kod	Size/Boyut	Weight/Ağırlık	m ³	Price/Fiyat
2R IR40PT 14	1400x400x1600	27 kg	0.89	514 €
2R IR60PT 14	1400x600x1600	41 kg	1.34	618 €
2R IR80PT 14	1400x800x1600	54 kg	1.79	752 €
2R IR40PT 16	1600x400x1600	32 kg	1.02	546 €
2R IR60PT 16	1600x600x1600	48 kg	1.53	663 €
2R IR80PT 16	1600x800x1600	64 kg	2.04	815 €
2R IR40PT 19	1900x400x1600	38 kg	1.21	594 €
2R IR60PT 19	1900x600x1600	57 kg	1.82	732 €
2R IR80PT 19	1900x800x1600	76 kg	2.43	928 €
2R IR40PT 24	2400x400x1600	48 kg	1.53	715 €
2R IR60PT 24	2400x600x1600	72 kg	2.30	888 €

demonte modelleri mevcuttur.

Shelving Systems/Raf Sistemleri/İstif Rafı

Wall Shelf Single Row/Duvar Rafı Tek Sıra

- Stainless steel – Paslanmaz çelik
- Scotch-Brite sanding – Parlatılmış Yüzey



Code/Kod	Size/Boyut	Weight/Ağırlık	m ³	Price/Fiyat
2R DR30TS 10	1000x300x30	5 kg	0.009	141 €
2R DR30TS 20	2000x300x30	9 kg	0.018	199 €

Wall Shelf Double Row/Duvar Rafı Çift Sıra

- Stainless steel – Paslanmaz çelik
- Scotch-Brite sanding – Parlatılmış Yüzey



Code/Kod	Size/Boyut	Weight/Ağırlık	m ³	Price/Fiyat
2R DR30IS 10	1000x300x30	5 kg	0.009	210 €
2R DR30IS 20	2000x300x30	9 kg	0.018	312 €

- Different dimensions are available
- Değişik ebatlar mevcuttur

Hoods/Davlumbazlar

GENERAL FEATURES

- Hood type working with injection emission system
- Exhaust air is pushed towards the filters with conditioned fresh air for better exhaust extraction
- Proportional fresh air distribution is provided by the perforated sheet structure at the air inlet section.
- Filters and air outlet areas are sized to prevent condensation.
- Completely made of stainless steel.
- It has a heat-resistant and transparent cover lighting system. Labyrinth filters are easy to remove for cleaning

GENEL ÖZELLİKLER

- Enjeksiyon emisyon sistemi ile çalışan davlumbaz tipidir
- Egzost edilen hava şartlandırılmış temiz hava ile filtrelere doğru itilerek daha iyi egzost çekişi sağlanır
- Hava giriş kısmındaki perfore saç yapısı sayesinde orantılı taze hava dağılımı sağlanmaktadır.
- Filtreler ve hava çıkış alanları yoğunlaşmayı engellemek için uygun ebatlandırılmıştır.
- Tümüyle paslanmaz çelikten imal edilmiştir.
- Isıya dayanıklı ve şeffaf kapaklı aydınlatma sistemine sahiptir. Labirent tip filtreler temizlenmesi için kolay çıkartılabilir

Air Injection Hood/Hava Enjeksiyonlu Davlumbaz

- Stainless steel - Paslanmaz çelik
- Scotch-Brite sanding - Scotch-Brite zımparalama
- Durable - Dayanıklı



Code/Kod	Size/Boyut	Weight/Ağırlık	m ³	Price/Fiyat
2H CK10FD 15	1500x970x500	54 kg	1,02	1.339 €
2H CK10FD 20	2000x970x500	72 kg	1,34	1.639 €
2H CK10FD 25	2500x970x500	90 kg	1,66	1.949 €
2H CK10FD 30	3000x970x500	108 kg	1,99	2.375 €
2H CK10FD 35	3500x970x500	126 kg	2,31	2.608 €
2H CK10FD 40	4000x970x500	144 kg	2,63	2.789 €
2H CK12FD 15	1500x1170x500	65 kg	1,21	1.463 €
2H CK12FD 20	2000x1170x500	87 kg	1,60	1.706 €
2H CK12FD 30	3000x1170x500	130 kg	2,36	2.132 €
2H CK12FD 35	3500x1170x500	151 kg	2,74	2.375 €
2H CK12FD 40	4000x1170x500	174 kg	3,12	3.186 €
2H CK12FD 45	4500x1170x500	196 kg	3,50	3.362 €
2H CK12FD 50	5000x1170x500	218 kg	3,88	3.536 €
2H CK12FD 55	5500x1170x500	240 kg	4,26	3.979 €
2H CK12FD 60	6000x1170x500	260 kg	4,64	4.304 €
2H CK15FD 20	2000x1470x500	109 kg	1,97	1.788 €
2H CK15FD 25	2500x1470x500	137 kg	2,44	2.296 €
2H CK15FD 30	3000x1470x500	164 kg	2,92	2.596 €
2H CK15FD 35	3500x1470x500	192 kg	3,39	3.062 €
2H CK15FD 40	4000x1470x500	219 kg	3,86	3.260 €
2H CK15FD 45	4500x1470x500	247 kg	4,33	3.667 €
2H CK15FD 50	5000x1470x500	274 kg	4,80	3.922 €
2H CK15FD 55	5500x1470x500	302 kg	5,27	4.178 €
2H CK15FD 60	6000x1470x500	329 kg	5,74	4.683 €

Hoods/Davlumbazlar

Box Type/Kutu Tip

- Stainless steel - Paslanmaz çelik
- Scotch-Brite sanding - Scotch-Brite zımparalama
- Durable - Dayanıklı



Code/Kod	Size/Boyut	Weight/Ağırlık	m ³	Price/Fiyat
2H KT08FD 10	1000x800x500	29 kg	0,59	553 €
2H KT08FD 20	2000x800x500	58 kg	1,13	874 €
2H KT08FD 15	1500x800x500	44 kg	0,86	696 €
2H KT08FD 25	2500x800x500	73 kg	1,40	1011 €
2H KT08FD 30	3000x800x500	88 kg	1,67	1241 €
2H KT10FD 10	1000x970x500	35 kg	0,70	633 €
2H KT10FD 15	1500x970x500	53 kg	1,02	744 €
2H KT10FD 20	2000x970x500	70 kg	1,34	911 €
2H KT10FD 25	2500x970 x 500	88 kg	1,66	1.083 €
2H KT10FD 30	3000x970x500	105 kg	1,99	1.320 €
2H KT10FD 35	3500x970x500	123 kg	2,31	1.449 €
2H KT10FD 40	4000x970x500	140 kg	2,63	1.550 €
2H KT12FD 12	1200x1170x500	48 kg	0,99	658 €
2H KT12FD 15	1500x1170x500	60 kg	1,21	813 €
2H KT12FD 20	2000x1170x500	79 kg	1,60	948 €
2H KT12FD 25	2500x1170x500	99 kg	1,98	1.185 €
2H KT12FD 30	3000x1170x500	120 kg	2,36	1.320 €
2H KT12FD 35	3500x1170x500	140 kg	2,74	1.554 €
2H KT12FD 40	4000x1170x500	158 kg	3,12	1.770 €
2H KT12FD 45	4500x1170x500	178 kg	3,50	1.868 €
2H KT12FD 50	5000x1170x500	198 kg	3,88	1.964 €
2H KT12FD 55	5500x1170x500	218 kg	4,26	2211 €
2H KT12FD 60	6000x1170x500	210 kg	4,64	2.391 €
2H KT15FD 15	1500x1470x500	81 kg	1,50	916 €
2H KT15FD 20	2000x1470x500	70 kg	1,97	993 €
2H KT15FD 25	2500x1470x500	88 kg	2,44	1.276 €
2H KT15FD 30	3000x1470x500	105 kg	2,92	1.442 €
2H KT15FD 35	3500x1470x500	123 kg	3,39	1.701 €
2H KT15FD 40	4000x1470x500	140 kg	3,86	1.812 €
2H KT15FD 45	4500x1470x500	158 kg	4,33	2.037 €
2H KT15FD 50	5000x1470x500	175 kg	4,80	2.179 €
2H KT15FD 55	5500x1470x500	193 kg	5,27	2.321 €
2H KT15FD 60	6000x1470x500	210 kg	5,74	2.602 €

Değişik ebatlar mevcuttur
Different dimensions are available

Hoods/Davlumbazlar

Island Type With Filter/Orta Tip Filtreli

- Stainless steel – Paslanmaz çelik
- Scotch-Brite sanding – Scotch-Brite zımparalama
- Durable – Dayanıklı



Code/Kod	Size/Boyut	Weight/Ağırlık	m ³	Price/Fiyat
2H OT15FD 15	1500x1470x500	59 kg	1.50	912 €
2H OT15FD 20	2000x1470x500	78 kg	1.97	1.085 €
2H OT15FD 25	2500x1470x500	98 kg	2.44	1.301 €
2H OT15FD 30	3000x1470x500	117 kg	2.92	1.553 €
2H OT15FD 35	3500x1470x500	137 kg	3.39	1.707 €
2H OT15FD 40	4000x1470x500	156 kg	3.86	1.967 €
2H OT15FD 45	4500x1470x500	176 kg	4.33	2.225 €
2H OT15FD 50	5000x1470x500	195 kg	4.80	2.388 €
2H OT20FD 25	2500x1970x500	131 kg	3.22	1.488 €
2H OT20FD 30	3000x1970x500	158 kg	3.85	1.688 €
2H OT20FD 35	3500x1970x500	184 kg	4.47	1.908 €
2H OT20FD 40	4000x1970x500	210 kg	5.09	2.188 €
2H OT20FD 45	4500x1970x500	236 kg	5.71	2.355 €
2H OT25FD 25	2500x2470x500	164 kg	4.00	1.691 €
2H OT25FD 30	3000x2470x500	197 kg	4.78	1.910 €
2H OT25FD 35	3500x2470x500	230 kg	5.55	2.106 €
2H OT25FD 40	4000x2470x500	263 kg	6.32	2.417 €
2H OT25FD 45	4500x2470x500	294 kg	7.09	2.667 €
2H OT25FD 50	5000x2470x500	329 kg	7.86	2.911 €
2H OT25FD 55	5500x2470x500	361 kg	8.63	3.085 €
2H OT25FD 60	6000x2470x500	394 kg	9.40	3.284 €
2H OT30FD 30	3000x2970x500	238 kg	5.71	2.111 €
2H OT30FD 35	3500x2970x500	278 kg	6.63	2.292 €
2H OT30FD 40	4000x2970x500	318 kg	7.55	2.485 €
2H OT30FD 60	6000x2970x500	476 kg	11.23	3.816 €

Değişik ebatlar mevcuttur
Different dimensions are available

Hoods/Davlumbazlar

Wall Type With Filter/Duvar Tip Filtreli

- Stainless steel - Paslanmaz çelik
- Scotch-Brite sanding - Scotch-Brite zımparalama
- Durable - Dayanıklı



Code/Kod	Size/Boyut	Weight/Ağırlık	m ³	Price/Fiyat
2H DT08FD 15	1500x800x500	39 kg	0.86	654 €
2H DT08FD 25	2500x800x500	65 kg	1.40	950 €
2H DT08FD 30	3000x800x500	78 kg	1.67	1166 €
2H DT10FD 10	1000x970x500	32 kg	0.70	594 €
2H DT10FD 15	1500x970x500	47 kg	1.02	699 €
2H DT10FD 20	2000x970x500	64 kg	1.34	855 €
2H DT10FD 25	2500x970x500	80 kg	1.66	1.017 €
2H DT10FD 30	3000x970x500	96 kg	1.99	1.239 €
2H DT10FD 35	3500x970x500	112 kg	2.31	1.361 €
2H DT10FD 40	4000x970x500	128 kg	2.63	1.455 €
2H DT12FD 12	1200x1170x500	45 kg	0.99	615 €
2H DT12FD 15	1500x1170x500	57 kg	1.21	763 €
2H DT12FD 20	2000x1170x500	61 kg	1.60	890 €
2H DT12FD 25	2500x1170x500	76 kg	1.98	1.113 €
2H DT12FD 30	3000x1170x500	92 kg	2.36	1.239 €
2H DT12FD 35	3500x1170x500	107 kg	2.74	1.459 €
2H DT12FD 40	4000x1170x500	122 kg	3.12	1.662 €
2H DT12FD 45	4500x1170x500	137 kg	3.50	1.754 €
2H DT12FD 50	5000x1170x500	152 kg	3.88	1.844 €
2H DT12FD 55	5500x1170x500	167 kg	4.26	2.076 €
2H DT12FD 60	6000x1170x500	183 kg	4.64	2.245 €
2H DT15FD 15	1500x1470x500	72 kg	1.50	860 €
2H DT15FD 20	2000x1470x500	96 kg	1.97	933 €
2H DT15FD 25	2500x1470x500	119 kg	2.44	1.198 €
2H DT15FD 30	3000x1470x500	144 kg	2.92	1.354 €
2H DT15FD 35	3500x1470x500	167 kg	3.39	1.597 €
2H DT15FD 40	4000x1470x500	191 kg	3.86	1.701 €
2H DT15FD 45	4500x1470x500	215 kg	4.33	1.913 €
2H DT15FD 50	5000x1470x500	239 kg	4.80	2.046 €
2H DT15FD 55	5500x1470x500	263 kg	5.27	2.179 €
2H DT15FD 60	6000x1470x500	288 kg	5.74	2.443 €

Değişik ebatlar mevcuttur
Different dimensions are available

Hoods/Davlumbazlar

Wall Type Without Filter/Duvar Tip Filtresiz

- Stainless steel – Paslanmaz çelik
- Scotch-Brite sanding – Scotch-Brite zımparalama
- Durable – Dayanıklı
- Adjustable height leg – Yüksekliği ayarlanabilir ayaklar



Code/Kod	Size/Boyut	Weight/Ağırlık	m ³	Price/Fiyat
2H KT08ZD 15	1500x800x500	30 kg	0.86	499 €
2H KT08ZD 25	2500x800x500	50 kg	1.40	944 €
2H KT08ZD 30	3000x800x500	60 kg	1.67	1.007 €
2H KT10ZD 10	1000x970x500	24 kg	0.70	427 €
2H KT10ZD 15	1500x970x500	36 kg	1.02	579 €
2H KT10ZD 20	2000x970x500	48 kg	1.34	710 €
2H KT10ZD 25	2500x970x500	60 kg	1.66	976 €
2H KT10ZD 30	3000x970x500	72 kg	1.99	1.039 €
2H KT10ZD 35	3500x970x500	85 kg	2.31	1.109 €
2H KT10ZD 40	4000x970x500	96 kg	2.63	1.200 €
2H KT12ZD 12	1200x1170x500	35 kg	0.99	505 €
2H KT12ZD 15	1500x1170x500	43 kg	1.21	623 €
2H KT12ZD 20	2000x1170x500	58 kg	1.60	792 €
2H KT12ZD 25	2500x1170x500	72 kg	1.98	999 €
2H KT12ZD 30	3000x1170x500	86 kg	2.36	1.050 €
2H KT12ZD 35	3500x1170x500	100 kg	2.74	1.117 €
2H KT12ZD 40	4000x1170x500	114 kg	3.12	1.229 €
2H KT12ZD 45	4500x1170x500	129 kg	3.50	1.352 €
2H KT12ZD 50	5000x1170x500	143 kg	3.88	1.487 €
2H KT12ZD 55	5500x1170x500	157 kg	4.26	1.636 €
2H KT12ZD 60	6000x1170x500	171 kg	4.64	1.799 €
2H KT15ZD 15	1500x1470x500	54 kg	1.50	615 €
2H KT15ZD 20	2000x1470x500	72 kg	1.97	821 €
2H KT15ZD 25	2500x1470x500	90 kg	2.44	969 €
2H KT15ZD 30	3000x1470x500	108 kg	2.92	1.100 €
2H KT15ZD 35	3500x1470x500	126 kg	3.39	1.272 €
2H KT15ZD 40	4000x1470x500	144 kg	3.86	1.399 €
2H KT15ZD 45	4500x1470x500	162 kg	4.33	1.539 €
2H KT15ZD 50	5000x1470x500	180 kg	4.80	1.692 €
2H KT15ZD 55	5500x1470x500	198 kg	5.27	1.862 €
2H KT15ZD 60	6000x1470x500	216 kg	5.74	2.048 €

Değişik ebatlar mevcuttur
Different dimensions are available

Address

Bahcelievler Mah. Sakarya Cad. No:11 Yazibasi Torbali / İzmir – Turkey
Tel: +90 232 853 92 00 / Fax: +90 232 853 91 99
info@kusina.com.tr / www.kusina.com.tr